



# Fisheries Centre Research Reports

---

*1998 Volume 6 Number 2*

## **Use of Ecopath with Ecosim to Evaluate Strategies for Sustainable Exploitation of Multi-Species Resources**

ISSN 1198-6727

**Use of Ecopath with Ecosim  
to Evaluate Strategies for  
Sustainable Exploitation of  
Multi-Species Resources**

*Fisheries Centre Research Reports  
1998 Volume 6 Number 2*

Use of Ecopath with Ecosim to Evaluate Strategies for Sustainable  
Exploitation of Multi-Species Resources:

Proceedings of a Workshop held at the  
Fisheries Centre

University of British Columbia,

Vancouver, B.C., Canada,

March 25-27, 1998

*edited by*

*Daniel Pauly*

*with the assistance of*  
*Gunna Weingartner*

*Published by*

*The Fisheries Centre,  
University of British Columbia  
2204 Main Mall, Vancouver, B.C.  
Canada, V6T 1Z4*

*ISSN 1198-6727*

## **ABSTRACT**

This report presents background material to and the main conclusions of a workshop, held on March 25-27, 1998 at the Fisheries Centre, UBC, and devoted to the use of the Ecopath with Ecosim software as a tool for evaluating different strategies for fisheries resource management in a multispecies, i.e., ecosystem context.

Summaries of lectures describing the latest version of Ecopath with Ecosim (V. Christensen), the background, capabilities and shortcomings of Ecosim (C. Walters), including the use of Ecosim in an economic context (R. Sumaila) to assess the effectivity of marine protected areas (R. Watson) and for rebuilding ecosystem (T. Pitcher) are presented. The main features of Ecospace, a spatial version of Ecopath recently developed by C. Walters, are briefly outlined.

The requirements of FAO - the main sponsor of the workshop - for field use of the package are presented (K. Cochrane), as are the results of tests and simulations by the workshop participants.

The report concludes with a general discussion of the type of prediction (safe, tentative, guesses) that can be expected to result from Ecosim/Ecospace applications.

## Director's Foreword

Fisheries science, based since the Second World War almost exclusively on single species population dynamics, has been conspicuously unable to answer, and often has failed even to pose, questions about the impacts of fishing on marine ecosystems. In fact, changes to ecosystems after the collapse of stock have generally caught fisheries scientists by surprise. Contrary to the previous view that fishing has hardly any effect on either the structure or composition of marine ecosystems, it is gradually being realized that the historical impacts of fishing have been large, dramatic and difficult to reverse. Fishing has seriously depleted biodiversity within and among species, reduced trophic linkages, caused local extinctions and compromised the economic value of marine resources. Fisheries scientists are only just beginning to recognize that these questions are the most important of our day, since without quantitative evaluations of ecosystem changes under alternative fishing policies, we will be powerless to reverse trends that, in the face of modern fishing gear technology, will likely result, within a generation, in the devastation of our oceans.

More than twenty researchers from international organizations, fisheries research institutions and academia, and graduate students, gathered for a workshop sponsored by FAO at the UBC Fisheries Centre from March 25-27, 1998. The aim was a preliminary exploration of the potential of some new analytical tools based on ecosystem models for comparing policy objectives in multispecies fisheries. FAO intends to follow this up with a second workshop, at another location, in about one year.

This was the second Fisheries Centre workshop based on the Ecopath modeling system. The first, in November 1995, led directly to the development of Ecosim by Carl Walters (published in 1997) in which the set of simultaneous linear equations estimated by Ecopath is used to parameterize the differential equations which, when integrated, allow dynamic responses to changes in mortality due to fishing to be modeled. The use of Ecopath, itself in an improved version, and integrated with Ecosim, was the primary focus of the meeting.

The present workshop also saw the launching of Ecospace, the first spatial modeling tool based on whole ecosystems. Ecospace will likely revolutionize the planning and design of marine reserves.

The 'Use of Ecopath with Ecosim to Evaluate Strategies for the Sustainable Exploitation of Multispecies Resources' is the tenth in a series of workshops sponsored by the UBC Fisheries Centre. The workshop series aims to focus on broad multidisciplinary problems in fisheries management, to provide a synoptic overview of the foundations and themes of current research, and identifies profitable ways forward. Edited reports of the workshops are published as Fisheries Centre Research Reports and distributed to all workshop participants. Further copies are available on request for a modest cost-recovery charge.

*Tony J. Pitcher*

Professor of Fisheries  
Director, UBC Fisheries Centre

## **Preface and Acknowledgments**

The purpose of the workshop documented in this report was to investigate the use of a recently developed ecosystem tool, Ecosim, to study the biological and economic impact of different harvesting regimes, based on files representing trophic models of a range of aquatic system types, previously constructed using the Ecopath approach and software.

This report contains (1) brief descriptions of Ecopath (vers. 4.0) and its Ecosim routine, with particular emphasis on the features important in simulating multi-species exploitation and its impacts; (2) descriptions of simulated fishing regimes and their impacts; (3) descriptions of problems encountered during the simulations and of the means these problems were or could in principle be overcome; and (4) discussions of the strength and weaknesses of Ecosim as a tool for simulating fisheries impacts on ecosystems, and of possible ways to improve the software and its underlying theory.

The participants of this workshop were largely drawn from the Fisheries Centre, UBC, where Ecopath is widely used, and where Ecosim was developed, but also included invited participants from further afield, most familiar with Ecosim, or at least with Ecopath.

The valuable result obtained during this workshop is a clear understanding of the potential usefulness of Ecopath, Ecosim and Ecospace, tempered by a realistic understanding of their limitations. Just right for a three-day event!

I wish to thank the participants for their enthusiasm, and particularly Kevern Cochrane, of FAO, for the clear goals he provided, Villy Christensen and Felimon 'Nonong' Gayanilo, for the timely completion of an alpha version of Ecopath 4.0, including Ecosim and Ecospace, Rashid Sumaila and Reg Watson for their lectures, and Carl Walters for his outstanding presentations of the background of Ecosim and Ecospace, and for leading the workshop's concluding discussion. Also, I wish to thank Ms. Gunna Weingartner for her preparation of and organizational support during the workshop.

Funding for this event and the attendance of several participants from abroad was provided by the Food and Agriculture Organization of the United Nations (FAO), though the Trust Fund Project GCP/INT/ 643/JPN sponsored by the Government of Japan as part of its follow-up to the Kyoto Conference on the Sustainable Contribution of Fisheries to Food Security.

The David and Lucille Packard Foundation provided additional funding for some participants from the US Northwest, while ICLARM provided funding for the participants from the Philippines, and the European Commission for a European participant. I thank all organizations for their support, and hope that this report makes palpable some of the excitement generated during the workshop, which their generosity allowed us to organize.

The Editor  
Vancouver, May 1998

## Table of Contents

<b>ABSTRACT</b> .....	1
<b>DIRECTOR’S FOREWORD</b> .....	2
<b>PREFACE AND ACKNOWLEDGMENTS</b> .....	3
<b>TABLE OF CONTENTS</b> .....	4
<b>LIST OF EXHIBITS</b> .....	5
<b>INTRODUCTION</b>	
FAO’S INTEREST IN AND EXPECTATIONS OF THIS WORKSHOP ( <i>K.COCHRANE</i> ).....	6
ECOPATH/ECOSIM APPLICATIONS IN THE EASTERN BERING SEA ( <i>A. TRITES</i> ).....	8
<b>LECTURES</b>	
THE NEW ECOPATH WITH ECOSIM ( <i>V.CHRISTENSEN</i> ).....	9
ECOSIM AND ECOSPACE: BASIC CONSIDERATIONS ( <i>C. WALTERS</i> ).....	11
ECOSIM AND MPAS: A QUASI-SPATIAL USE OF ECOSIM ( <i>R. WATSON AND C. WALTERS</i> ).....	15
BIOECONOMICS AND THE ECOPATH/ECOSIM FRAMEWORK ( <i>R. SUMAILA</i> ).....	19
ECOSYSTEM SIMULATION MODELS AND THE NEW ‘BACK TO THE FUTURE’ APPROACH TO FISHERIES MANAGE- MENT ( <i>T. PITCHER</i> ) .....	21
<b>COMMENTS</b>	
STRATEGIES FOR SUSTAINABLE USE OF MULTI-SPECIES RESOURCES ( <i>A. BUNDY</i> ).....	24
FIRSTS THOUGHTS ON USES, STRENGTH, AND WEAKNESSES OF ECOPATH ( <i>K.COCHRANE</i> ).....	24
BACK TO THE FUTURE WITH ECOPATH AND ECOSIM ( <i>N. HAGGAN</i> ).....	26
ECOPATH AND ECOSIM APPLICATIONS TO MARINE MAMMALS AND BIRDS ( <i>K. HEISE</i> ).....	26
HABITAT CONSIDERATION FOR USING ECOPATH/ECOSIM ( <i>A. JARRE-TEICHMANN</i> ).....	27
ECOPATH, ECOSIM, MPAS, AND PELAGIC SYSTEMS ( <i>J. KITCHELL</i> ).....	28
EVALUATING STRATEGIES OF SUSTAINABLE EXPLOITATION ( <i>P. LIVINGSTON</i> ).....	29
THE NEED FOR ALERT USERS ( <i>J.J. MAGUIRE</i> ).....	30
ECOSIM APPLICATION TO LAKE VICTORIA ( <i>J.MOREAU</i> ).....	30
THE PRINCE WILLIAM SOUND MODEL ( <i>T. OKEY</i> ).....	32
MODELING THE EASTERN CENTRAL PACIFIC OCEAN ( <i>R. OLSON</i> ).....	34
ECOPATH, ECOSIM AND EVALUATING POLICY IN AN ECOLOGICAL CONTEXT ( <i>A. PARMA</i> ).....	34
IMPROVING FOOD WEB DESCRIPTIONS FOR USE IN DYNAMIC SIMULATIONS ( <i>D. PAULY</i> ).....	36
<b>DISCUSSION</b>	
POLICY USE AND LIMITATIONS OF THE ECOPATH APPROACH ( <i>R. WATSON AND D. PAULY</i> ).....	38
<b>REFERENCES</b> .....	44
<b>APPENDIX 1</b>	
Workshop Schedule.....	47
<b>APPENDIX 2</b>	
LIST OF PARTICIPANTS.....	48

## List of Exhibits

Box 1 Basic equations, assumptions and parameters of the Ecopath approach.....	10
Box 2 Inputs required to turn Nile perch into a split pool.....	31
Fig. 1 Simplified representation of trophic interactions in the Central South China Sea....	11
Fig. 2 A feeding triangle in the South China Sea ecosystem. ....	12
Fig. 3 How, in Ecosim, prey groups are split into available, and unavailable biomass. ....	12
Fig. 4 Representing the linkages of a grid cell in Ecospace.....	13
Fig. 5 How Ecopath groups may be partitioned into MPA and non-MPA portions.....	15
Fig. 6 Exchange of biomass between MPA and non-MPA biomass portions.....	16
Fig. 7 Response of biomass after 10 years in Lingayen Gulf, Philippines.....	17
Fig. 8 Catches with MPAs of varying ‘sizes’ after 10 years, Thai 10 model.....	17
Fig. 9 Biomass response to a slow migration rate, Thai 10 model.....	18
Fig. 10 Biomass response after 10 years of fast migration rate, Thai 10 model.....	18
Fig. 11 Schematic representation of present and past ecosystems.....	23
Fig. 12 Coarse-grid map of Prince William Sound, Alaska.....	33
Fig. 13 Food web incorporating subsystems at lower trophic levels.....	37

## INTRODUCTION

---

### FAO Fisheries Department Interest in and Expectations of this Workshop

**Kevern L. Cochran**  
*Fishery Resources Division, FAO*

Amongst many other important principles, the FAO Code of Conduct for Responsible Fisheries (FAO, 1995) highlights the importance of multi-species approaches to fisheries management. For example, Paragraph 12.5 recommends that “States should be able to monitor and assess the state of stocks under their jurisdiction, including the impacts of ecosystem changes resulting from fishing pressure, pollution or habitat alteration. They should also establish the research capacity necessary to assess the effects of climate or environmental change on fish stocks and aquatic ecosystems.”

This issue was also identified as being of particular importance at the Kyoto Conference held in Japan in 1995. The Kyoto Declaration (Anon, 1995) arising from this meeting called upon signatories, among other things:

- To conduct integrated assessments of fisheries in order to evaluate opportunities and strengthen the scientific basis for multi-species and ecosystem management
- To promote allocation of human and financial resources for an international programme to investigate the effectiveness of multi-species management of commercial fishery resources.

After the Kyoto Conference, the Japanese Government established a trust fund to be administered by the Fisheries Department of FAO, to follow up on a number of recommendations contained within the declaration, including that above, to promote a strengthened scientific basis for multi-species and ecosystem management.

Progress in understanding of multi-species dynamics in fisheries has been slow and many processes and principles of ecosystem functioning are still very poorly understood. Nevertheless, some progress has been made. In fisheries, there has been some progress in developing methods to increase our ability to assess fisheries as multi-species systems and hence also manage them as such (Walters et al. 1997).

Probably the most comprehensive of these approaches is that of Multi-Species Virtual Population Analysis (MSVPA). The major drawback of MSVPA is that it requires a large amount of data and information for application. The Ecopath approach, which relies on a ‘snap-shot’ of biomass pools and flows between them, as well as exports and imports, has been developed to require much less data and hence to be applicable in a much wider range of fisheries systems. In recent years, substantial progress has been made with the Ecopath approach, both in terms of the number of systems to which it has been applied and in the types of applications. Within the latter category, Ecoranger (allowing incorporation of uncertainty), Ecosim (allowing simulation of ecosystem variables over time) and Ecospace (adding a spatial dimension to Ecopath) have been particularly important developments (see Christensen, this vol., and Walters, this vol. for brief descriptions of these tools).

With reference to Ecosim, Walters et al. (1997; 1998) have suggested that it has the following potential uses:

- testing hypotheses about ecosystem functions;
- policy screening for proposed ecosystem management strategies;
- consistency checking for hypotheses about impact of long-term regime shifts;
- evaluation of possible trophic causes for non-stationarity in single-species recruitment relationships.

The second of these potential uses, policy screening, is particularly relevant to the multi-species requirements of the Code of Conduct and to the Kyoto Declaration. FAO therefore approached the Fishery Centre, University of British Columbia, where several of the key scientists working on Ecopath are based, to host a workshop to evaluate the current status and capabilities of the Ecopath suite of assessment tools for potential application in multi-species assessment and management. The objectives of the workshop were defined as:

- to investigate the use of the Ecopath suite of software as a tool to study the impacts of different harvesting approaches on simulated ecosystems, with a view to application of suitable approaches in actual multi-species fisheries; and

- to identify and document the strengths and weaknesses of the Ecopath approach in this role.

If the Ecopath models are found, in some or all cases, to provide acceptably realistic representations of real ecosystems, then it would open up the possibility of using Ecopath or Ecopath-type models to explore different management strategies and to identify the most appropriate strategy for implementation. This concept could lead to the use of such an ecosystem model as an operating model in a multi-species management procedure.

A management procedure has been defined as a set of rules which specifies exactly how a management recommendation (e.g., TAC, length of closed season, size of closed area etc.) is set and what data are used for this purpose (Butterworth et al. 1997). These rules are selected based on their anticipated performance in the medium term (e.g. 10 - 20 years), as estimated by simulation on an 'operating model' of the resource and fishery or fisheries. Performance is defined in terms of selected indicators related to the resource and the desired benefits (typically including indices of risk of undesirable impacts on the resources, benefits to the users and inter-annual variability in these benefits).

In developing a management procedure, an integral and essential part of the process consists of ensuring that the selected set of rules is robust to likely uncertainties in the forecasts and data or observations.

Based on this more formal approach to using an ecosystem model to guide management strategies, the broad objectives of the workshop can be broken down into more specific questions to be addressed at this workshop:

- Does the Ecopath with Ecosim approach encompass sufficient understanding of the dynamics of a multi-species ecosystem for a user to have a reasonable expectation that the real system will respond to a management strategy in the same way as estimated by Ecopath with Ecosim?
- As a part of the previous question, can the Ecopath structure simulate adequately the fishery (or other use) as a component of the system, including sufficient information on e.g. age and species selectivities of gear?
- Can the major sources of uncertainty be included and considered in an Ecopath analysis?
- Once all reasonable uncertainty has been considered, is there any 'signal' remaining

which will enable robust forecasts of ecosystem response to a management strategy?

- Can the common indicators for performance criteria be included in Ecopath with Ecosim, and generated as an output from the system?

Clearly there are no absolute answers to these questions and the answers will vary amongst ecosystems and depend on the existing knowledge of the system and on the management strategies that are being considered. Nevertheless, it is hoped that this workshop will provide adequate answers to these questions to aid people considering using the Ecopath suite, or an equivalent approach, to decide whether this will assist them in their attempts to understand and manage multi-species fisheries.

## **Ecopath/Ecosim applications in the Eastern Bering Sea**

***Andrew Trites***

***Marine Mammal Research Unit, Fisheries Centre***

For the past eight months, a team of researchers from the Fisheries Centre has been working with collaborators from the University of Alaska and the US National Marine Fisheries Service (NMFS) to construct ecosystem models of the eastern Bering Sea (1950s; and late 1980s - early 1990s) using Ecopath. The work, involving Pat Livingston (NMFS; see Livingston, this vol.) and the author, has been supported by the David and Lucille Packard Foundation and is in the final stages of write-up. The more recent model representing the Eastern Bering Sea is one of the most detailed ecosystem models constructed to date and should become a useful tool for fisheries managers charged with applying ecosystem concepts to the Bering Sea fisheries.

Ecosystem modeling is still in its infancy, but stands to become a central tool in fisheries management. It is therefore important that ecosystem models, such as ours, convey insights and uncertainties to managers and fishers if they are to be used to enhance the conservation of marine life. There is probably no better way to ensure this than to draw on the collective experiences and insights gained by others using Ecopath and Ecosim.

We were particularly pleased, therefore, that funds from the Packard Foundation became available to support the travel and participation of three researchers constructing ecosystem models of the Bering Sea, the Gulf of Alaska and the Pribilof Islands. The lessons learned by comparing our approaches and findings to those of researchers working on other ecosystems will be invaluable in ensuring that our results end up on the management table and become a useful tool for fisheries management in the North Pacific.

## LECTURES

---

### The new Ecopath with Ecosim, version 4.0 Alpha.

*Villy Christensen*  
*ICLARM*

Over the last two years, work has been in progress to develop a new version of Ecopath which integrates the Ecosim module for dynamic simulation modeling based on mass-balanced Ecopath models (Box 1).

This development has involved Carl Walters and Daniel Pauly at the Fisheries Centre, and Villy Christensen at ICLARM. At this Ecosim workshop, an incomplete Alpha version was used. The version incorporates Ecopath with most of its modules, plus Ecosim and the newly developed Ecospace module for spatial modeling (see Walters, this vol.).

In my opening lecture at the first workshop session, when I gave an overview of the new version of Ecopath, the following features were highlighted:

- The new version is programmed for 32-bit Window system, and cannot be used with Window 3.1. Previously constructed models are now saved in a MBD-format database allowing for straightforward communication with other databases, notably FishBase (Froese and Pauly 1998). For each model it is possible to save scenarios run with Ecoranger, Ecosim and Ecospace. The new database format is downward compatible with the previous 'EII' file format;
- The new version allows for entry of more detailed description of species included in the ecosystem groupings;
- It is possible to enter up to 10 gears or fleets in each model. For each gear, landings, discards, market prices, fixed and variable costs can be entered. In addition a non-market value can be given for each ecosystem group. The breakdown in gears and inclusion of simple bio-economic parameters is of relevance especially for fishery policy analyses using Ecosim (see Sumaila, this vol.);

- The Ecoranger module for parameterization of models using distributions or ranges for all basic input parameters and for addressing uncertainty in a Bayesian context, has been improved. Also, it is now possible, when Ecoranger cannot find any balanced model, to save the best unbalanced model (BUM);
- The 'Ecowrite' system for adding and storing remarks and references and documenting inputs has been considerably expanded and now includes a system for documenting results as well. Also, the module for extracting and editing remarks and references has been improved.

The version used at the workshop was a test version, and a number of bugs were found during the workshop. This did not have any major significance for the course of the workshop and most participants were able to explore the software, its characteristics and abilities. Several of the participants had a good knowledge of the software prior to the workshop, which enabled them to work at an advanced level.

The bugs that were identified will be fixed before the Beta version is sent for testing. This will be done as soon as the development and documentation process has been completed. Meanwhile the Alpha version can be downloaded from [www.ecopath.org](http://www.ecopath.org), or is available through Villy Christensen at [v.christensen@cgnet.com](mailto:v.christensen@cgnet.com).

**Box 1. Basic equations, assumptions and parameters of the Ecopath approach**

The mass-balance modeling approach used in this workshop combines an approach by Polovina and Ow (1983) and Polovina (1984, 1985) for estimation of biomass and food consumption of the various elements (species or groups of species) of an aquatic ecosystem (the original ‘ECOPATH’) with an approach proposed by Ulanowicz (1986) for analysis of flows between the elements of ecosystems. The result of this synthesis was initially implemented as a DOS software called ‘ECOPATH II’, documented in Christensen and Pauly (1992a, 1992b), and more recently in form of a Windows software, Ecopath 3.+ (Christensen and Pauly 1995, 1996). The ecosystem is modeled using a set of simultaneous linear equations (one for each group *i* in the system), i.e.

Production by (*i*) - all predation on (*i*) - nonpredation losses of (*i*) – biomass accumulation of (*i*)  
 - export of (*i*) = 0, for all (*i*).

This can also be put as

$$P_i - M_{2i} - P_i(1 - EE_i) - Bacc_i - EX_i = 0 \quad \dots 1)$$

where  $P_i$  is the production of (*i*),  $M_{2i}$  is the total predation mortality of (*i*),  $EE_i$  is the ecotrophic efficiency of (*i*) or the proportion of the production that is either exported or predated upon,  $(1 - EE_i)$  is the ‘other mortality’,  $Bacc_i$  is the biomass accumulation of (*i*), and  $EX_i$  is the export of (*i*).

Equation (1) can be re-expressed as

$$B_i * P/B_i - \sum_j B_j * Q/B_j * DC_{ij} - P/B_i * B_i(1 - EE_i) - Bacc_i - EX_i = 0 \quad \dots 1)$$

or

$$B_i * P/B_i * EE_i - \sum_j B_j * Q/B_j * DC_{ij} - Bacc_i - EX_i = 0 \quad \dots 2)$$

where  $B_i$  is the biomass of (*i*),  $P/B_i$  is the production/biomass ratio,  $Q/B_i$  is the consumption/biomass ratio and  $DC_{ij}$  is the fraction of prey (*i*) in the average diet of predator (*j*).

Based on (2), for a system with *n* groups, *n* linear equations can be given in explicit terms:

$$B_1 P/B_1 EE_1 - B_1 Q/B_1 DC_{11} - B_2 Q/B_2 DC_{21} - \dots - B_n Q/B_n DC_{n1} - Bacc_1 - EX_1 = 0$$

$$B_2 P/B_2 EE_2 - B_1 Q/B_1 DC_{12} - B_2 Q/B_2 DC_{22} - \dots - B_n Q/B_n DC_{n2} - Bacc_2 - EX_2 = 0$$

$$B_n P/B_n EE_n - B_1 Q/B_1 DC_{1n} - B_2 Q/B_2 DC_{2n} - \dots - B_n Q/B_n DC_{nn} - Bacc_n - EX_n = 0$$

This system of simultaneous linear equations can be solved through matrix inversion. In Ecopath, this is done using the generalized inverse method described by MacKay (1981), which has features making it generally more versatile than standard inverse methods.

Thus, if the set of equations is overdetermined (more equations than unknowns) and the equations are not consistent with each other, the generalized inverse method provides least squares estimates which minimize the discrepancies. If, on the other hand, the system is undetermined (more unknowns than equations), an answer that is consistent with the data (although not unique) will still be output.

Generally only one of the parameters  $B_i$ ,  $P/B_i$ ,  $Q/B_i$ , or  $EE_i$  may be unknown for any group *i*. In special cases, however,  $Q/B_i$  may be unknown in addition to one of the other parameters (Christensen and Pauly 1992b). Exports (e.g., fisheries catches) and diet compositions are always required for all groups.

A box (or “state variable”) in an Ecopath model may be a group of (ecologically) related species, i.e., a functional group, a single species, or a single size/age group of a given species.

## Ecosim and Ecospace: basic considerations<sup>b</sup>

**Carl Walters**  
*Fisheries Centre, UBC*

This brief contribution, adapted from the material presented at two lectures, includes only pointers to the more detailed descriptions of Ecosim (Walters et al. 1997; Walters et al. 1998), and Ecospace (Walters et al.; see below for Abstract.), which should be consulted for further details.

The main elements of Ecosim are:

- Ecopath is used for estimation of parameters, based on the assumption of mass-balance;
- Biomass and size structure dynamics: are represented by a mix of differential and difference equations;
- Variable speed splitting is used to model the dynamics of both 'fast' (e.g., plankton) and 'slow' (e.g., top predators) groups;
- Micro-scale behavior is represented by allowing differentiation between top-down, intermediate and bottom-up control of predation.

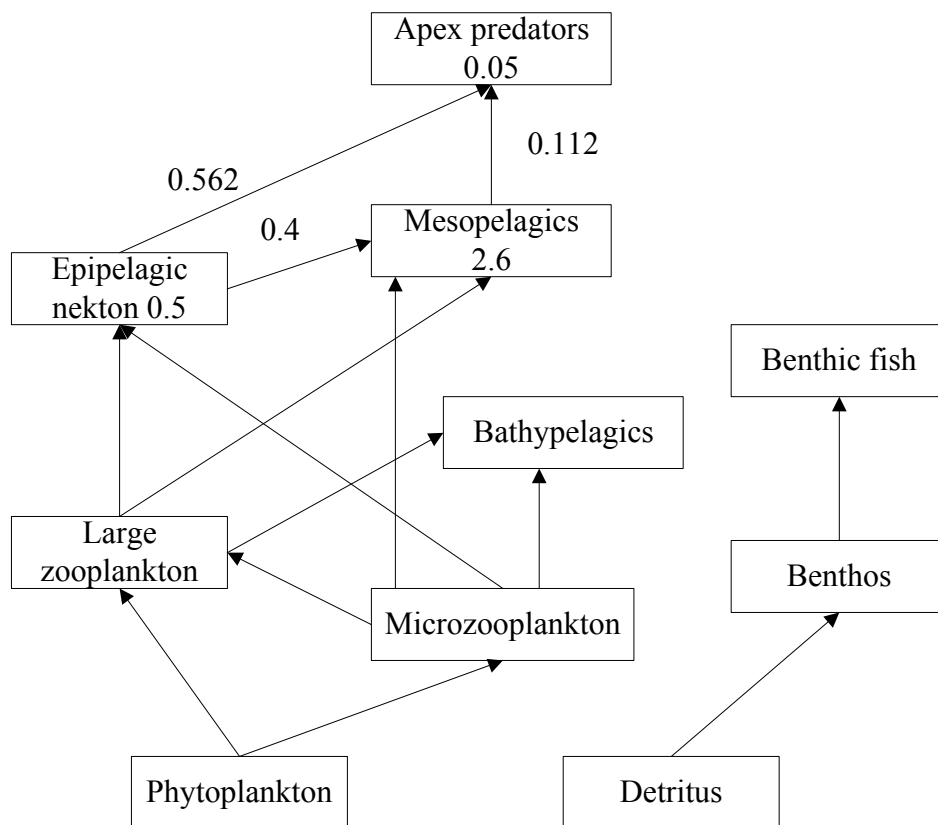

**Fig. 1 Simplified representation of trophic interactions in the Central South China Sea, indicating the biomass of some groups ( $t \cdot km^2$ ) and the fluxes between them ( $t \cdot km^2 \cdot year^{-1}$ ).**

<sup>b</sup> Editorial note: this contribution is based on the PowerPoint presentation used by Carl Walters for the two lectures he gave at the Workshop, with text added by the editor to smooth the transition between ideas and/or graphs previously in separate exhibits.

Interaction parameters between, e.g. the Apex predators, the Epipelagic nekton and the Mesopelagics (Fig.2) can be computed from the data in Fig. 1, viz.

$$Q(\text{epipelagics to Apex}) = 0.562$$

$a(\text{epipelagics, Apex}) = 0.562 / (0.5 * 0.05)$  for Lotka-Volterra model, i.e., top-down control, and

$Q = aV_i B_j = a v_{ij} B_i B_j / (2v_{ij} + a B_j)$  for prey vulnerability limitation.

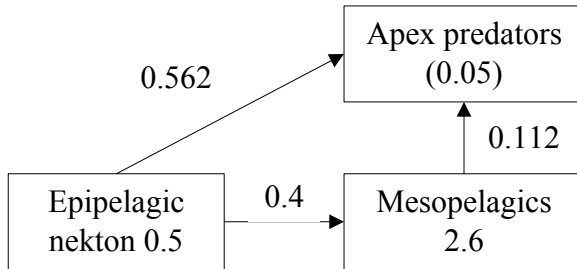

**Fig. 2 A feeding triangle in the South China Sea ecosystem, with data required to compute interaction parameters (see Fig.1).**

Representing limited prey vulnerability is achieved, in Ecosim, by splitting each group's biomass into an available and an unavailable component (Fig. 3).

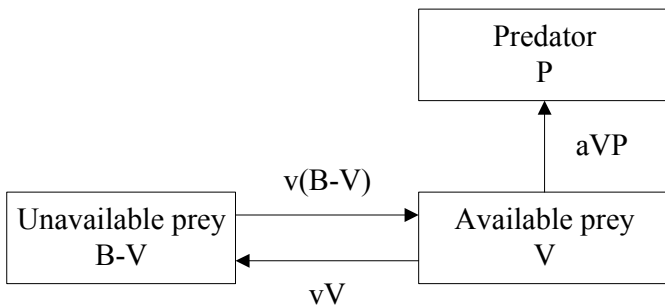

**Fig. 3 Illustrating how, in Ecosim, the biomass of a prey group is split into an available and an unavailable component. The symbols stand for: B = Total prey biomass; V = Vulnerable prey biomass; v = Behavioral exchange rate; P = Total predator biomass; a = Predator rate of search. Note that fast equilibration between B-V and V implies  $V = vB / (2v + aP)$ .**

The dynamics of biomass is, in Ecosim, represented by differential equations of the form

$$\begin{aligned} dB/dt = & (\text{Consumption}) \\ & - (\text{Predation}) \\ & + (\text{Immigration}) \\ & - (\text{Emigration}) \\ & - (\text{Fisheries catches}). \end{aligned}$$

Their terms are defined by :

(Consumption) =  $\Sigma$  (micro-scale rates);

(Predation) =  $\Sigma$  (micro-scale rates); and

$$\begin{aligned} (\text{Micro-scale rate}) = & a B_{\text{pred}} v V_{\text{prey}} \\ = & a B_{\text{pred}} B_{\text{prey}} v / (v' + a B_{\text{pred}}). \end{aligned}$$

Size-structured dynamics are considered only in 'split pools', which include the juveniles and adults of the same pool. For these, we have:

- Juvenile size/age structure by monthly cohorts, density- and risk- dependant growth;
- Adult numbers, biomass, mean size accounting via delay-difference equations; and
- Recruitment relationship as an emergent property of competition/predation interaction of juveniles.

The remaining critical gaps and weaknesses of Ecosim are:

- a) the parameter estimation does not account for highly seasonal environments;
- b) meso-scale spatial relationships, i.e., migration are not accounted for;
- c) effects of change in habitat quality on trophic relationships can be represented only crudely;
- d) the articulation of policy option leaves much to be desired; and
- e) emergent novelty cannot be considered; the model predicts opportunities for the growth of populations already included in the model, while, at least in highly disturbed systems, increased vulnerability to invasion should be predicted.

We should be able to address several of these deficiencies in the near future, notably (a) – (d). Item (e), on the other hand, will continue to plague us, as models such as discussed here have difficulties dealing with novelty. The next routine to present is Ecospace, recently developed to provide a spatial dimension to the Ecopath approach. As it presently stands, Ecosim has the following features:

- Replicates Ecosim dynamics over a coarse grid of ‘homogenous’ cells;
- Spatial cells are linked through dispersal, and the allocation and movement of fishing effort;
- Spatial differences in primary productivity are represented; and
- Habitat ‘preferences’ are represented by differential dispersal, feeding, and predation rates.

The Ecospace dispersal linkage may be represented as in Fig. 4, where the  $m$ ’s are assumed equal (symmetrical mixing), except at shores, and toward preferred habitat (a smoothing procedure generates the gradient used to ex-

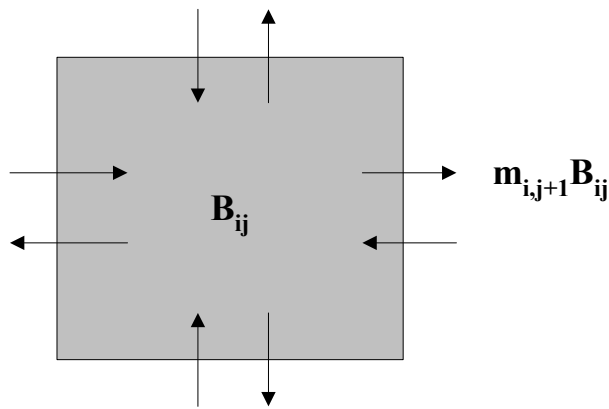

tend the ‘reach’ of preferred habitat).

**Fig. 4 Representing the linkages of a grid cell in Ecospace.**

The computational method involved in Ecospace involves a huge system of equations (20x20 grid for 10 pool model results in 4000 differential equations). Solving such a system of

equations requires either much patience or a numerical approximation scheme. Lacking the former, I have included in Ecospace a numerical approximation by linearization involving a matrix exponential solution method. This produces rapidly converging, successive approximations of spatial equilibrium. The method is efficient, but it is a good thing to always test for step size effects.

Given the present unavailability of documentation for Ecospace, I include below the abstract of a paper titled: “Ecospace: a software tool for predicting mesoscale spatial patterns in trophic relationships of exploited ecosystems, with special reference to impacts of marine protected areas”, by Carl Walters, D. Pauly and V. Christensen, which will be presented at Theme Session (S) on ‘Visualization of Spatial (including Survey) Data’, of the ICES Annual Science Conference, Cascais, Portugal, September 1998. Here we go:

The growing disillusion with the predictive capability of single species assessment methods, and the realization that the management approaches they imply will always fail to protect bycatch species, has led to growing interest in the potential of marine protected areas (MPAs) as a tool for protecting such species, and allowing for rebuilding populations of target species and damaged habitat.

Evaluating MPAs’ abilities to meet these requirements will demand both field experiments and simulations. However the tools required for the latter need not be as detailed as is often thought, and particularly, need not include links between resource species and physical processes.

Ecospace is a spatially explicit model for policy evaluation which allows considering the impact of MPAs in an ecosystem (i.e., trophic) context, and which relies on the Ecopath mass-balance approach for most of its parametrization.

Additional inputs are movement rates, used to compute exchanges between grid cells, the settings (top-down vs. bottom up control) also required for Ecosim, the dynamic simulation routine derived from the system of linear equations in Ecopath and habitat preferences for each of the functional groups included in the model.

Convergence from the homogenous distribution assumed in the Ecopath base model to highly patterned distributions, simultaneously accounting for the habitat preference and food requirements of predators and preys, the distribution of fishing effort (driven by local abundances and fishing costs) and the existence of MPAs is extremely rapid, due to an integration scheme with different step sizes for the 'fast' and 'slow' groups, allowing the former to track the population changes of the latter.

An application example for coastal waters off Brunei, (Southeast Asia) is presented, documenting the ability of Ecospace to generate realistic spatial distributions of functional groups, under constraints of habitat preference, distribution of fishing effort, etc.

'Cascade' effects, wherein prey organisms are low where predators are abundant, e.g. in areas onto which high fishing costs have been mapped, or in MPAs are discussed; it is then shown that the potential benefits of local effort reductions can be easily negated by high movement rates, and especially by the concentration of fishing effort at the edge of the MPAs, where cascade effects generate prey gradients which attract predators out of the protected areas.

Despite various limitations (e.g., no explicit consideration of seasonal changes or directed migration), the outward simplicity of Ecospace, and the information-rich graphs it generates, coupled with the increasingly global availability of the required Ecopath files, should ensure a wide use for this approach, both for generating hypotheses about ecosystem function and evaluating policy choices.

## Ecosim and MPAs: a quasi-spatial use of Ecosim

**Reg Watson**

**Fisheries Western Australia, Perth and**

**and**

**Carl Walters**

**Fisheries Centre, UBC**

While the first version of Ecosim (Walters et al. 1997) offered many facilities to managers, it did not provide a means of describing the spatial relations of biomass and fishing mortalities which are required to examine the potential impacts of marine protected areas (MPAs). To overcome this, we devised a simple modification to Ecosim which allows the biomass of Ecopath groups to be partitioned into two portions (Figure 5) with exchange processes operating between them (Figure 6).

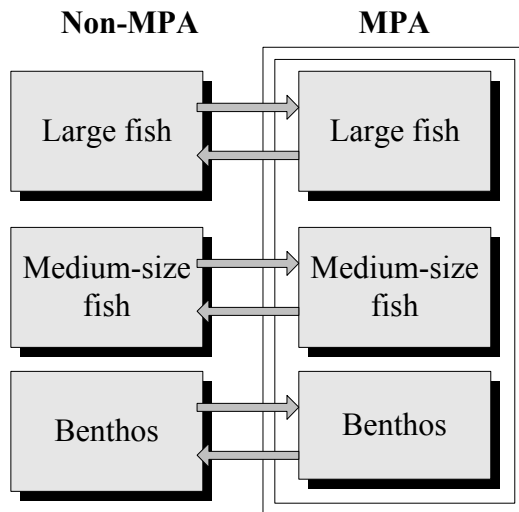

**Fig. 5 Schematic representation of how the biomass of Ecopath groups may be partitioned into MPA and non-MPA portions.**

One biomass portion would be assumed to be within an MPA and subject to different levels of fishing mortality (at least for some groups) than the other portion. If the biomass of Ecopath groups is assumed to be uniformly distributed in space, then the proportion of the biomass assumed to be in the MPA is also the proportion of the area of the marine system (described by the Ecopath) that is included in the MPA. This assumption allowed us to observe the impact of MPA 'size' and biomass exchange rates on the calculated biomasses and catches of Ecopath groups.

The rate of biomass movement of each Ecopath group out of the MPA was defined as

$$R_{\text{out}} = X / \sqrt{P}$$

where X is a user supplied value and P is the proportion of biomass or the portion of the fishery described by the Ecopath model included in the MPA.

The balanced movement of biomass into the MPA is defined as

$$R_{\text{in}} = X / (P (1 - B))$$

The response of biomass and catch for a range of published Ecopath models were examined for MPA proportions ranging up to 80% of the total fishing ground. For each, a 10-year period was simulated and the harvest from the fishery was maintained by allowing the fishing mortality acting on the non-MPA biomass pools to increase as the MPA portion increased (up to a maximum of three times the original Ecopath model value).

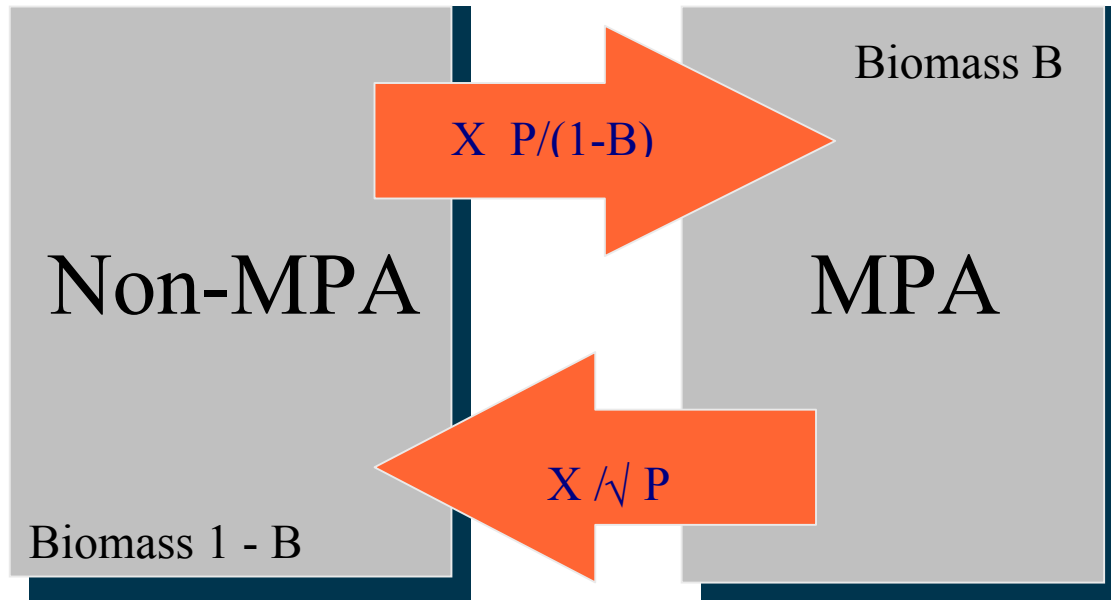
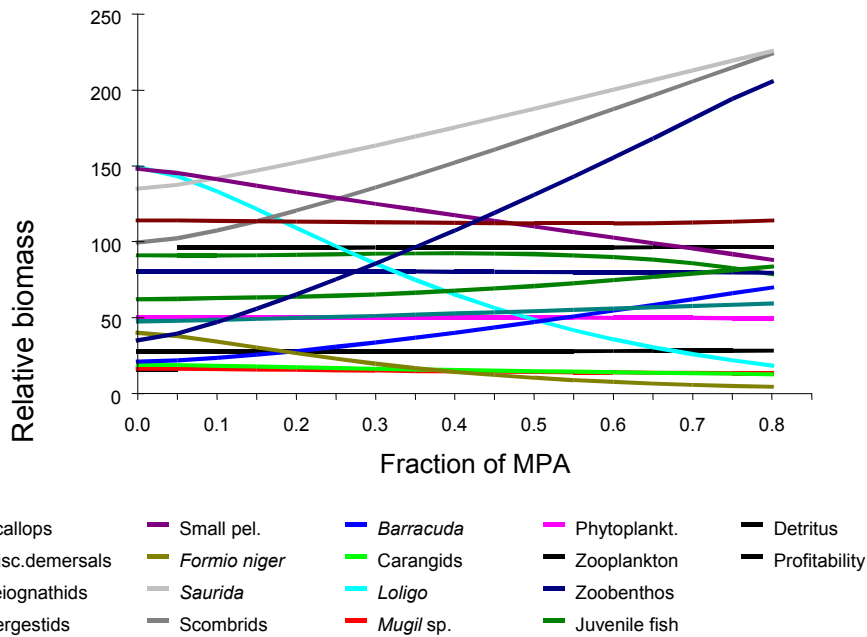

**Fig.6 Exchange of biomass between MPA and non-MPA biomass portions. Parameter X is a user-supplied migration value and P is the proportion of the Ecopath group's biomass within the MPA.**

As expected, Ecopath models with low fishing mortalities did not exhibit large changes in biomass or catch from Ecopath levels even when a large proportion of the biomass was protected from fishing mortality within an MPA. In others, a range of responses was observed ranging from a simple linear increase or decrease (Figure 7), to that of a dome-shaped curve with an MPA 'size' corresponding to a maximum biomass and catch (Figure 8). Most impacted were heavily-fished top predators and their prey.

The biomass and catch responses of Ecopath models to MPA size was sensitive to assumptions about X, the user-supplied migration rate, but this depended on the model or group under consideration. For a given MPA size, low migration rates allowed greater biomass increases (Figure 9), while higher migration rates exposed biomass to fishing mortality and reduced

the impact of the MPA (Figure 10). Higher migration rates required larger MPAs, and the scale of the response was determined by the level of fishing mortality assumed in the Ecopath model. Early indications from work with Ecospace, a true spatial model (see Walters, this vol.), suggest that our findings are overly optimistic because the spatial aggregation of fishing effort at the borders of an MPA will reduce the average biomass response within the MPA.



**Fig.7 Response after 10 years of biomasses in Lingayen Gulf Philippines, as a function of the fraction of MPA to total ecosystem area [file: LINGAYEN]**

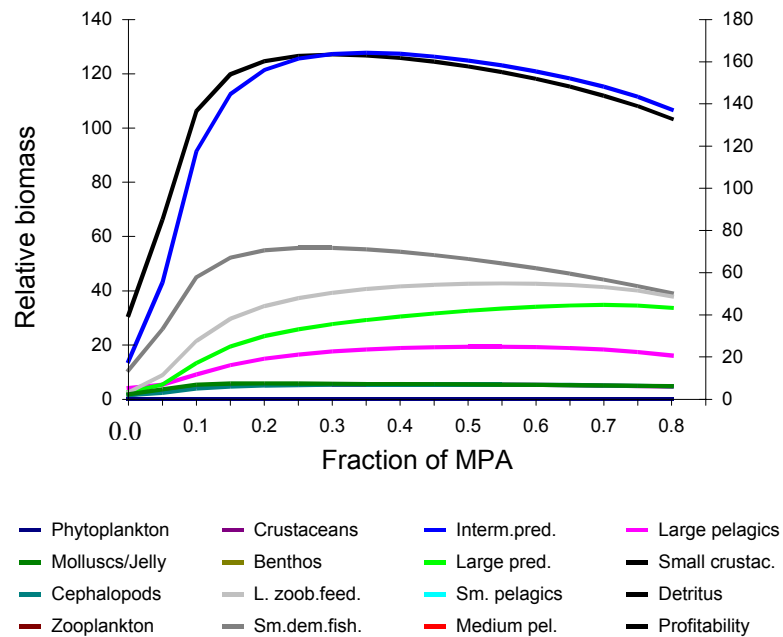

**Fig. 8 Catch response with MPAs of varying 'sizes' after 10 years, inshore waters of the Gulf of Thailand [file Thai10]**

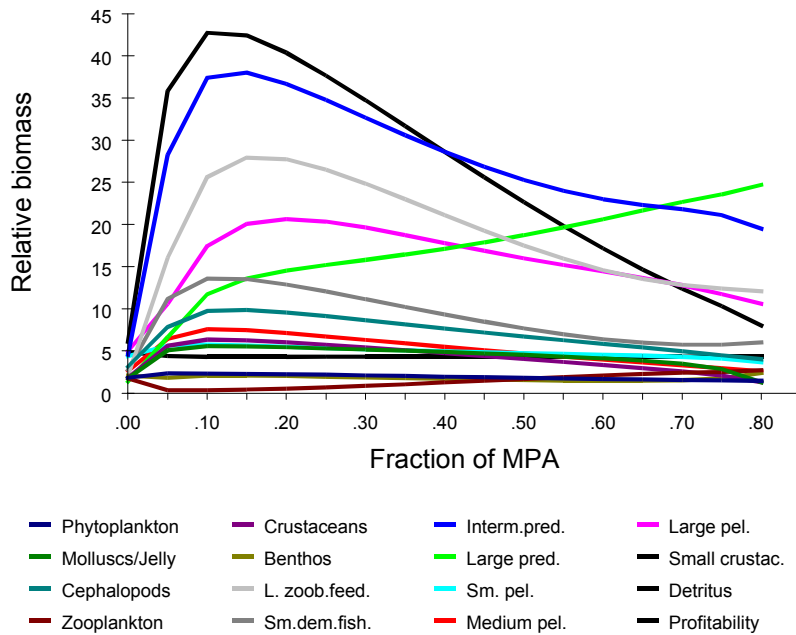

**Fig. 9 Biomass response to a slow migration rate ( $X = 0.5$ ) of Thai10 Ecopath model to MPAs of varying 'sizes' after 10 years**

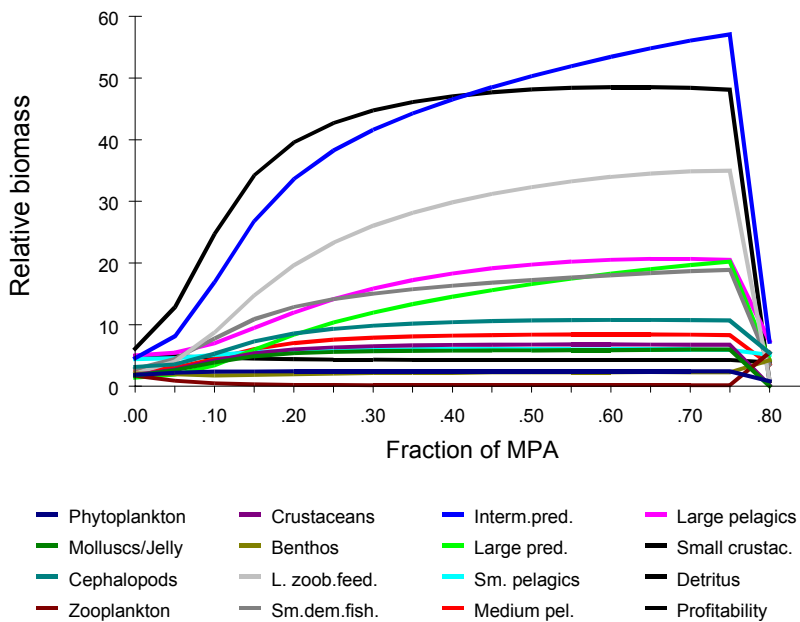

**Fig. 10 Biomass response of Thai 10 Ecopath model to MPAs of varying 'sizes' after 10 years of a fast migration rate ( $X = 4$ ). Note that calculations can break down when both MPA fraction and migration rate are large.**

## **Bioeconomics in the Ecopath/Ecosim Framework**

***Ussif Rashid Sumaila***  
***Chr. Michelsen Institute, Bergen and***  
***Fisheries Centre, UBC***

This contribution does three things. First, it addresses the question of how to extend the Ecopath/Ecosim framework to allow the performance of bioeconomic analysis at the level of the ecosystem. The paper identifies two ways to do this: either by undertaking a basic or an advanced analysis. Second, the presentation covers what has been done so far to introduce bioeconomics into the framework by way of an example. Finally, a proposal is put across on how to proceed with the agenda of extending the Ecopath/Ecosim framework to allow the bioeconomic evaluation of different scenarios of exploiting fishery resources in an ecosystem. To pursue the objective of the presentation, the talk is divided into the following four sub-topics, (i) basic bioeconomic analysis, (ii) advanced bioeconomic analysis, (iii) an example, and (iv) next steps: a proposal.

### Basic bioeconomic analysis

The simplest way to introduce bioeconomics into the Ecopath/Ecosim framework is to take the biological results (catches and fishing effort) generated by Ecopath/Ecosim under different scenarios, and apply appropriately determined unit prices for the fish landed, the cost of exploiting the fish, and the discount rate. In this way, we are able to compute the net discounted economic rent that can be achieved under the different scenarios, which in turn allows us to determine the scenario that produces the best ecologically sustainable economic outcome. The point should be stressed here that this approach is only a basic and simple bioeconomic analysis, mainly because economic motivations do not enter into the decisions made regarding how much of what species to harvest, and when the harvest should be taken. All we do, which is very useful thing to do, is to evaluate alternative biological outcomes using economic parameters (that is, prices, costs and discount rates).

### Advanced bioeconomic analysis

Advanced analysis deals with the limitations of the basic analysis by incorporating into the analysis the regulatory body's and/or fishers'

behavior and motivations for fishing. This method does so by identifying who the stakeholders are, and incorporating what they care about. This is done by defining and incorporating the objective functions and decision variables of the participants into the analysis. It is then possible, through some optimization procedures, to determine the harvest mix that gives the highest economic benefits without disturbing the ecological balance and impairing the sustainability of the ecosystem.

Fundamental questions that need to be answered in order to design the analysis here include (i) who controls the fishery? Is it a single, powerful, benevolent controller who decides how much of what species to harvest? (ii) Or do the fishers with the right to exploit the ecosystem go about the exploitation on their own? (iii) If the answer to question (ii) is yes, do the fishers work together in a cooperative manner or in a noncooperative one?

Answers to these questions will set the stage for designing a truly bioeconomic model of the ecosystem based on Ecopath/Ecosim. What is more, the answers will allow us to analyze the distribution of the economic benefits to be derived under different management strategies or policies (see Sumaila, 1997).

### An example using Hong Kong Fisheries

An Ecopath/Ecosim model for Hong Kong fisheries, with a network of MPAs and artificial reefs (ARs) is developed in this example (see Munro and Sumaila, in press; Sumaila, in press). Different scenarios were created and the model run to produce various biological results in the form of biomass, catches and fishing effort levels, for different species of fish in Hong Kong waters.

A basic bioeconomic analysis of this fishery was carried out (i) by determining appropriate unit prices for each group of fish in the fishing habitats of Hong Kong using available data; (ii) working cost of landing a unit of a particular group of fish using a given vessel type; and (iii) determining an appropriate discount rate for Hong Kong. Combining (i)-(iii) with the catch and effort levels obtained from Ecopath/Ecosim, a basic bioeconomic analysis was done, generating the net economic gains that can be achieved by incorporating different sizes of MPAs and ARs. Thereby, making it possible to determine the MPA and AR combinations that give the best economic outcomes (Munro and Sumaila, in press).

Next steps: A proposal

In the short term, I think we should concentrate on developing and improving the basic bioeconomic analysis. This improvement can be brought about by developing good databases on prices and costs. However, the long term goal should be to incorporate the behavior and mo-

tivations of fishers and fisheries managers into the bioeconomic analysis. In fact, work on the latter can form a good basis for a Ph.D. thesis, and interested candidates may contact the author, or either of Drs. Pauly and Pitcher to explore this further.

## **Ecosystem Simulation Models and the new Back to the Future Approach to Fisheries Management**

*Tony J. Pitcher*

The rebuilding of resources, rather than sustainability, represents a new policy goal for fisheries management (Pitcher and Pauly 1998). Such a policy likely represents the only hope for the future for fisheries targeting wild living resources, which have been progressively and seriously depleted (e.g. Pauly et al. 1998). This approach attempts to reverse the ratchet-like-ecological processes caused by human fishing, which have been largely ignored by a fisheries science primarily concerned with single species population dynamics (Pauly and Pitcher 1998; Pitcher in press a).

In the 'Back to the Future' (BTF) approach, scientific tools are used to construct and evaluate present and past ecosystems. The policy objective for management becomes the rebuilding of the past system that would, if restored, maximise economic benefit to society. The approach is fundamentally different from a policy goal of sustainability, which leads only to sustaining our present misery.

In summary, the BTF agenda for fisheries management comprises six elements:

1. model construction of present and past aquatic ecosystems;
2. evaluation of economic and social benefits for each system;
3. choice of system that maximises benefits to society;
4. design of instruments to achieve this policy goal;
5. evaluation of costs of these management measures;
6. adaptive implementation and monitoring of management measures.

A marine ecosystem model of the present day is used as the starting point for a reconstruction of the system as it might have been prior to the start of modern industrial fishing. Models of several past systems are constructed using data from archives, government and universities including fisheries management databases, the traditional environmental knowledge (TEK) of Indigenous Peoples, the local environmental knowledge of commercial and sport fishers (LEK), and the archaeological record (Fig. 11).

Economic evaluations may take into account present values in global seafood markets, revenue foregone because of overfishing and stock collapses (see Sumaila, this vol.), and social, cultural, amenity and conservation values. The social benefits include reduced inter-sectoral conflict. Evaluation also includes the costs of implementing and monitoring restoration. Practical restoration techniques to achieve the new policy goal call upon Marine Protected Areas in addition to conventional fishery management (Watson and Walters, this vol.; Pitcher in press a)

Workshops to help build models of past systems can act as a neutral forum where opposing sectors meet and share knowledge in the interest of long-term conservation. Comparing species levels predicted by the model with TEK and other perspectives on past abundance provides both a talking point and a means of cross-validation. Focussing on past abundance highlights what could be achieved, as opposed to fighting over present scarcity (see also Haggan, this vol.). Moreover, when such policy goals are identified, an ecosystem-based agenda means that, during rebuilding, the public can act as sentinels of progress, and many diverse groups, including industry, aboriginal peoples, schools and colleges can have roles in providing data (Pitcher in press b). A sense of ownership of the process and goals fosters cooperation and reduces conflict. Restoration accords with the natural resource philosophy of many aboriginal peoples. Additionally, the BTF agenda provides an economic rationale for restoration that can benefit all sectors.

Ecosystem modeling, such as that covered in this workshop, has to be an integral part of the methodology required for the BTF approach. Mass-balance Ecopath and Ecosim modeling has advantages in making clear the impacts of harvest, comparing the effects of different gear types, and in being able to provide estimates of unknown biomasses. It can therefore validate anecdotal information on presence or absence, and relative abundance of fish species (Haggan, this vol.). A disadvantage is that in its present state of development, ecosystem modeling is not itself able to provide single species quotas because, generally, many species have to be combined into one 'box'. Conventional stock assessment methods will continue to be needed, but biomass values for single species will have to be constrained by the results of the ecosystem model. Ways of merging current sophisticated single species stock assessment methods

with ecosystem modeling of the impacts of harvest need to become an active research area. Ecospace modeling can play an important part in designing reserves and management tactics needed to achieve BTF policy goals. The Back to the Future approach to fisheries management is in its infancy, and many details remain to be worked out, but a pilot study has been carried out in the Strait of Georgia, B.C. Canada, and work is in progress in the nearby Hecate Strait, and in Hong Kong. Also, proposals for BTF work are being developed for several areas in Southeastern Indonesia. Watch this space!

Next page:

**Fig. 11 Schematic representations of present (right) and past (left) ecosystems, reconstructed using the Ecopath software and different types of source (written documents, oral history, archeological evidence). Dotted lines indicate range of reliable extrapolations using Ecosim, limited by structural changes such as caused by extinctions and invasions.**

# BACK TO THE FUTURE ➤ STRAIGHT OF GEORGIA

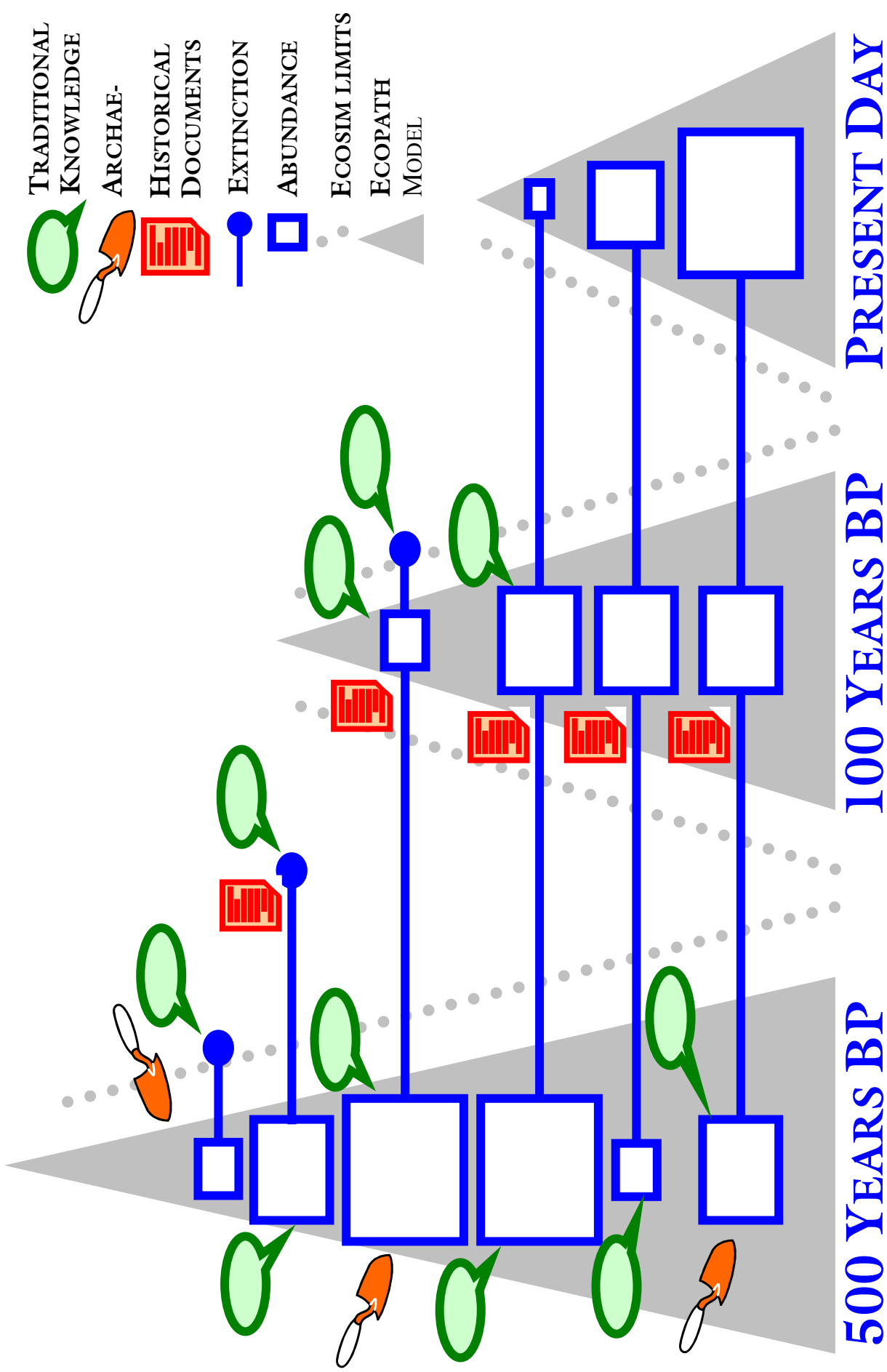

## COMMENTS

---

### **Strategies for Sustainable Exploitation of Multi-species Resources**

**Alida Bundy**

*DFO St. Johns, Newfoundland*

The following questions were asked by K. Cochrane (this vol.): Does Ecosim encompass adequate understanding of the system? Can it adequately simulate the fisheries? Can major uncertainties be combined? Is there sufficient certainty to give adequate robustness? Does Ecosim estimate indicators for performance?

I present a few comments regarding these questions. However, since the input parameters for Ecosim are taken from mass-balanced Ecopath models, I have focused on the use of Ecopath and the nature of inputs to this model.

In an applied fisheries situation where data is to be collected to construct an Ecopath model (as opposed to using models that are already constructed), there are considerable data requirements. Although, compared to models such as MSVPA, the data requirements are relatively small, the demands of this part of the Ecopath/Ecosim approach should not be underestimated. Carl Walters (unpublished data) has shown that, in particular, reliable diet composition data make the dynamic simulations more robust (see also Pauly, this vol.). At this stage, investing time into model parameterization is worthwhile. This serves at least two purposes. First of all it produces a better model and secondly it gives the model greater legitimacy. This latter point is relevant where construction of the model involves accessing outside expertise and 'selling' the model to managers, fishers and the public.

I also make this point because if Ecopath/Ecosim is to be used as a policy tool by FAO, then we are no longer dealing with idealized systems built from guesses based on experience with more or less comparable systems. Since the evaluation of policy strategies will be site-specific, a reasonable attempt should be made to obtain a good parameterization of the Ecopath model. In addition, if parameters are continually transferred from one to the other model, then the same few systems will be replicated and our arguments will become circular.

I think that the Ecopath/Ecosim approach is a very exciting development, allowing for wide exploration of many multispecies and ecosystem issues in fisheries. It opens a world simply not accessible before. The impact of fishing by different types of fishing gear on a multispecies resource can be explicitly examined under different hypotheses of flow regime ('bottom up', 'top down'...). With the addition of Ecospace, it has become possible to examine these interactions at a spatial level and to investigate the effect of MPAs.

At a practical level I found the software relatively straightforward to use, although like Heise (this vol.), I did have difficulty in inputting the parameters for the split pools, which had worked in an earlier version of Ecosim. It would have been good to have time to explore the new software in more detail.

### **First thoughts on uses, strengths and weaknesses of the Ecopath suite**

**Kevern Cochrane**

*Fisheries Department, FAO*

These comments are based largely on listening to the presentations and discussion during the Workshop, and some exploratory examination of the different components. I did not have the opportunity to undertake detailed simulations and evaluate the results for an ecosystem with which I am familiar.

#### 1. Limitations

In common with any modeling approach, the Ecopath suite has its limitations and it is important that these are carefully considered when Ecopath, Ecosim and Ecospace are used to assist in evaluation of management strategies.

Some of these are:

- 1.1 The models are based on food webs, and do not incorporate other features of ecosystems which may also be important. Examples of these include the role of physical factors in driving ecological processes (e.g. long-term trends in temperature), ecological interactions involving resources other than food, e.g. competition for space, etc;
- 1.2 The level of aggregation commonly encountered in food web data sets, particularly at the lower trophic levels, may mask resource partitioning (see Pauly, this vol.), resulting in incorrect simulations of interactions (e.g. food web analysis may indicate anchovy and sardine as important competitors. However, experience has indicated that these two species favour different ecological conditions even though the differences have not been clearly delineated; see also Jarre-Teichmann, this vol.);
- 1.3 Inevitably, there are high levels of uncertainty in the food web structure, arising from estimates of all the inputs. It is vital that the impact of these uncertainties is considered explicitly when using the models to guide management decisions. Ecoranger provides a means of quantifying some of these uncertainties and needs to be used in this role. The effect of assumptions on the results should also be checked;
- 1.4 At present, individual stocks can only be disaggregated into two age/size groups. This means that age effects, e.g. of fishing, can only be considered in an approximate manner, in contrast to many single-species approaches which allow explicit consideration of age/size structure.

## 2. Potential Uses

If the limitations of the Ecopath approach, such as those presented above, are considered in interpreting model output, there can be no doubt that the suite of models represents a major step forward in enabling routine consideration of management issues and plans in an ecosystem context. Depending on the system under consideration and the information available, the following applications can be envisaged in relation to fisheries management:

- 2.1 Ecosim provides a very useful approach for evaluating the multi-species impacts

of fisheries. Simulations under a variety of conditions, critically interpreted, would enable evaluation of ecosystem ramifications, providing input to planning of multi-species management approaches. It should be used with output from Ecoranger, or other information on uncertainties, to enable some robustness testing of management approaches;

- 2.2 Ecospace is a potentially widely applicable tool and will enable rapid screening of the spatial dynamics of, e.g. closed areas, heterogeneous distribution of fishing effort, impacts of changes in oceanographic features which influence primary production, etc. This is crucial, as the importance of considering the spatial characteristics of ecosystems, fisheries and stocks is increasingly being recognized. For many countries and stocks, the information and time may not be available for constructing site-specific spatial models. In these cases, Ecospace provides a user-friendly and easy to use tool for at least preliminary examinations of many of these problems.

Overall, I believe the package is extremely useful and, critically applied, can provide very useful information complementary to existing assessment/simulation methods. Its great value lies in the fact that it will enable at least some consideration to be given, within a structured framework, to ecosystem and spatial effects, in a wide range of cases where, until now, such features have been essentially overlooked.

## **Back to the future with Ecopath and Ecosim**

***Nigel Haggan***  
***Fisheries Centre, UBC***

Back to the Future (BTF) is a new approach which proposes rebuilding rather than sustainability as the proper goal of fisheries management (Pitcher and Pauly, 1998). The rationale is found both in recent work documenting the decline in trophic level brought about by industrial fishing (Pauly et al. 1998), and the long-standing concerns of indigenous and artisanal fishers about the effect of industrial harvest (Haggan, 1998).

The Ecopath mass-balance approach to aquatic ecosystem modeling has parallels with the way longstanding fishing communities view the environment. Both are more concerned with relationships, interactions and connections within an ecosystem than with achieving a deep understanding of isolated elements (Haggan, 1996). BTF uses Ecopath to re-construct the species composition, relative abundance and productive capacity of marine ecosystems at some past level, say before the onset of modern industrial fishing. For example, a recent BTF project of the UBC Fisheries Centre and the UBC First Nations House of Learning developed models of the Strait of Georgia ecosystem as it might have been 100 years and 500 years ago.

The first step is to create an Ecopath model of the present system. This can either be done as a student project, or as a major workshop bringing together experts in the various ecosystem components. Either way, the model focuses discussion and input from government science, university science, the traditional environmental knowledge (TEK) of indigenous communities, the knowledge of commercial and sport fishers, archival sources and the archaeological record. For almost the first time, the BTF methodology provides the TEK of aboriginal peoples and maritime communities with a valuable, direct function in resource management.

Perhaps even more importantly, three elements combine to promote cooperation between a diverse group of stakeholders. First, a university-based unit, such as the UBC Fisheries Centre, can act as a neutral forum where frequently opposing sectors can meet and share knowledge in the interest of long-term conservation. Second, comparing the abundance of species (or functional groups) in an Ecopath mass-balance model with TEK and other views provides a starting point for discussion, and an element of cross-validation. Third, the abundance in the

'good old days' may provide a useful contrast to the present, often inequitable access to the resources.

Economic evaluations of past ecosystems (see Sumaila, this vol.) can then be compared with the present. Restoration goals, which can be simulated using Ecosim, can be based on the economic, social, and cultural values attainable by rebuilding. It requires no great stretch of the imagination to see the same interests agreeing on rebuilding goals and working together on ways to get there.

Current BTF projects initiated through the Fisheries Centre, UBC include a reconstruction of the Hecate Strait ecosystem of northern British Columbia in cooperation with the Tsimshian and Haida Nations. Also, a re-construction of the Hong Kong fishery as it might have been 50 years ago, prepared by T. Pitcher and R. Watson will form the basis for a major workshop in Hong Kong (see also Pitcher, this vol.).

## **Ecopath and Ecosim applications to marine mammals and birds**

***Kathy Heise***  
***Marine Mammal Research Unit, Fisheries Centre***

It was really helpful to see how Ecopath has evolved since the 1995 Workshop (see Pauly and Christensen, 1996) and I have a better sense of the potential that Ecopath and Ecosim have to provide insight into how changes in biomass at one trophic level can be transferred through the food web. I felt in 1995, and continue to feel that going through the experience of developing a mass-balance model is a tremendously valuable heuristic process.

In terms of evaluating the software as a management tool, there were obvious limitations that were directly related to bugs in the present version of the software that make it difficult to provide intelligent comments. However, I can highlight a few areas that were of interest to me and which I would like to study further, once these bugs are removed. First, I would like to explore linking juvenile and adult age classes and test under which conditions the additional level of data that this separation implies is worth collecting. The juvenile age class of many fish species are important prey to marine mammals and seabirds and using Ecopath to see what the effects are of altering juvenile biomasses in higher trophic level predators would be very interesting. Because I couldn't link the

juvenile and adult classes during the workshop, I couldn't examine the effects of MPAs on to recruitment; I think this should be worth pursuing further. My own interest would then be to experiment with the placement of seabird colonies within the MPA and to find out at what distance the birds would receive benefits, if any. I also appreciated the option that Ecospace has to alter movement rates, and thought that this could be useful for experimenting with the effects of diffuse vs. tightly schooled fish and their vulnerability to predation by marine mammal and birds.

## **Habitat Consideration for using Ecopath/Ecosim**

***Astrid Jarre-Teichmann***  
***Danish Institute for Fisheries Research /***  
***Chair, ICES Habitat Committee***

The models which serve as background to this brief contribution were presented in Jarre-Teichmann (1995), and Jarre-Teichmann et al (in press) and refer to the Baltic Sea, and the Southern Benguela upwelling system, respectively.

Both models represent comparatively simple ecosystems with regard to species composition. They also share the feature that their components are largely determined by oceanographic settings. Further, the database for building both of these Ecopath models was relatively good. The split-pool groups in the Southern Benguela model were the two hake species with a 'small' (0-2 years) and 'large' (age 3+) group each. For the Baltic Sea, detailed age structures for the commercial fish species (sprat, herring and cod) were available from MSVPA assessment, itself based on long-term stomach time series of cod, the top predator. Therefore, the Ecopath model included 4 age groups for cod (0,1,2,3+) and 3 each for sprat and herring (0,1,2+), where the plus group represents the adult stock. Accordingly, the juvenile groups were aggregated for the Ecosim analyses.

Congratulations to Villy, Carl and Daniel for making available a tool which, already in its alpha version, runs better than the released versions of Ecopath 3, and for enabling ecosystem modeling to make a tremendous leap forward. I particularly value the potential of Ecopath/Ecosim to open a discussion between 'hard-core' fisheries (stock assessment) scientists and marine ecologists-oceanographers - chemists-ecotoxicologists. This discussion will

be crucial to any development towards ecosystem management.

As mentioned repeatedly during the workshop discussions, Ecosim runs do not show realistic behaviour for groups, whose habitat (or niche) is not primarily defined by trophic interactions. Sardine and anchovy, for example, compete for food in most upwelling systems. Hence, in Ecosim, one species can be favored strongly exploiting the other. However, when anchovy- or sardine-dominated regimes are observed in the real world, it is usually found to be due to wind-induced structuring of their reproductive habitat (Bakun, 1996). Similarly, recruitment success of cod is critically dependent on the oxygen conditions in the deep basins of the Baltic Sea (Jarre-Teichmann et al., submitted), which in turn depend on saltwater inflow into the Baltic from the North Sea.

To increase the ability of Ecosim to credibly respond to management questions, it would be helpful to allow it to explicitly address habitat-related issues, such as pollution; eutrophication, oxygen depletion, etc., and their effect on the size of suitable habitat.

Approaches for dealing with these issues may include:

- 1) developing the approach taken by J. Dalsgaard (Fisheries Centre, UBC, MSc. thesis, in prep.) for tracing radioactivity through the ecosystem into a generic, Ecopath-based routine for tracing the movements of pollutants through a food web;
- 2) allowing for inclusion of 'rules' in the simulation such as resulting from (a) threshold values for pollutants above which productivity would decrease and/or mortality would increase, or from (b) critical biomass levels of some components in the system, whose presence may be beneficial to others, but in a non-trophic way, e.g. by providing shelter;
- 3) recommending to users that environmental aspects of fishing, e.g. benthic habitat impacts through destruction of corals, sponges, etc., should be explicitly included in the simulations, along with the 'catches' and discarded by-catch thus generated. This would allow the related fluxes to be explicitly included in food webs, and thus provide a basis for addressing the issue of 'shelters', i.e. refuge from predation.

## **Ecopath, Ecosim, MPAs, and pelagic systems**

**James F. Kitchell**  
**University of Wisconsin**

This brief report offers an evaluation of my experience during the Ecopath/ Ecosim/Ecospace Workshop held at the UBC Fisheries Centre during 25-27 March 1998. First, I am strongly supportive of this effort and its continued development. I believe that the combination of models is a very powerful approach: Ecopath offers the benefit of a solid foundation created by delineating the components and their quantitative interactions; Ecosim allows the expansion of that condition through simulation of the response to future conditions; while Ecospace allows even greater capacity in viewing the spatial context of dynamic interactions and the consequences of management actions imposed on landscape-scale units of habitat.

As a learning exercise, I sought to use an Ecopath model we have constructed for the Central Pacific, then apply that to a general problem pertinent to questions about Marine Protected

Areas (MPAs) in a pelagic environment. I set up a series of simulations designed to evaluate the interactions between refuge size, mobility of the apex predators and differences in basic productivity of refuge habitat. Similar proportions of the habitat were set aside in each case, but set out as many individual units grading to a single, large unit. Each refuge was defined as an area where fishing was not pursued and, in the second series, where primary production was greater than in the surrounding habitat.

The main conclusions from that exercise are that:

- Apex predators with low swimming velocities effectively link a series of small and proximate MPAs. Populations of those predators in the general region of a refuge are enhanced above that of the effect within the refuge areas alone. Immobile apex predators increase within each of the discrete refuges. Highly mobile apex predators disperse the local effects and the effect of the refuges gradually disappears as predator mobility is increased. Similar, but reciprocal, effects occur among key prey resources;
- As refuge size was increased, positive effects on apex predators increased and negative effects on their prey became more apparent. In other words, large refuges amplify the effects of reduced exploitation on food web interactions;
- If the refuge habitat is characterized by higher productivity, trophic cascade effects appear at intermediate to large refuge sizes; these is also evidence of a long-term cyclical oscillation in all components of the food web. The period of that oscillation roughly corresponds to the life history characteristics (i.e., generation time) of the apex predators.

In summary, the workshop environment is important on two counts. First, the presentations by the developers of this software actually explained how it works, the conceptual framework embedded in its equations, and, equally important, how it won't work. In my experience, that understanding cannot be fully derived from readings, or from simply downloading and using the software. Second, the workshop provided opportunity for exchange of ideas and anecdotes that expanded the perspective of participants.

My only concern about this workshop focuses on the present state of the software. The user must have confidence that output of the modeling effort actually derives from the scenarios developed by the user and is not biased by unknown programming problems. This condition must be met in future workshops and, we hope, will soon be resolved through access to the completed beta version.

## **Evaluating strategies for sustainable exploitation**

*Pat Livingston*  
*Alaska Fisheries Science Center, Seattle*

The models I have used to evaluate Ecopath and its extensions are recently constructed models of the eastern Bering Sea shelf in the 1950s and 1980s (see Trites, this vol.). Previous exercises with these models indicated an inability to project from the 1950s state using Ecosim and to achieve the 1980s state, in both a quantitative and qualitative sense. The reasons for this are many and include the usual list of suspects: incomplete knowledge of the 1950s state and a model that does not contain any details on the early life history of gadoids implicated in the changes from a cold to a warm regime. Another cause might have been some unaccounted-for spatial dynamics. I am presently examining different levels of pollock in the 1950s that might come close to obtaining a pollock-dominated ecosystem in the 1980s.

Other scenarios I want to examine further are: (1) projecting the 1980s model forward to the present to see how closely it matches the present ecosystem state; and (2) using Ecospace to examine some hypotheses about spatial overlaps between certain key predators and prey. If we do not spend sufficient time examining model configurations and our ability to accurately predict multispecies changes either in a qualitative or quantitative sense under known conditions, then I do not see how we could hope

to convince management that advice obtained from this modeling framework is useful. Of course, I find these models extremely interesting and useful from a scientific point of view in developing and testing hypotheses about ecosystem structure and function. But making the leap from providing advice on future research efforts to providing advice to guide management actions will require meeting a certain burden of proof.

I would like to see some model facilities added to the package that could possibly aid in this endeavor. An iterative procedure that would try different combinations of parameter changes to go from a given historical Ecopath state to attempt to match a future observed state would be useful. Traditional stock assessment scientists often show how model estimates compare with observations and may also provide a way to incorporate time series of observations about the state of the population into the assessment procedure itself. Perhaps there is a way to incorporate time series of observations about biomass levels of certain ecosystem components into Ecosim's projections from the past, i.e., from a previously observed state to the present state.

I am still trying to sort out what management questions and what time scales can be addressed with Ecosim. In the Bering Sea, we have relatively conservative fishing regimes compared to other systems and this system definitely has seen cyclic fluctuations of important fish species in the last 25 years or so. Tony Pitcher's characterization of sustainability "sustaining our present misery" (see Pitcher, this vol.) is difficult to apply to this system because we are still trying to understand how the relatively light fishing effort can have induced the observed population fluctuations. Also, there is no clear ratcheting down of species. Thus, separating human effects from climate change effects is a very high priority for the Bering Sea, especially with regard to questions about what would happen to pollock production if we moved back into a cold regime. Other questions that fishery managers and stock assessment scientists are asking include: what are the effects of unequal harvesting rates on individual components of the groundfish complex on the resulting community composition? How does pulse fishing impact upper trophic level predators?

I need to do some further exploration of the behavior of the Ecopath/ Ecosim/ Ecospace package, and of its fit to observations, before I can judge whether it could be used to answer

these questions. I see the possibility that many interesting scientific and management questions might be addressed with Ecospace and look forward to the model exploration and validation that will be required for further moves in this direction.

## **The need for alert users**

**Jean-Jacques Maguire**  
*Halieutikos / Chair ICES ACFM*

Ecopath modeling is a useful way of summarizing and verifying information on ecosystem structure and functioning. The Ecopath/Ecosim combination makes it possible to investigate potential changes to the ecosystem as a result of fisheries management measures. Creative interpretation of the parameters can significantly expand the number and type of questions that can be investigated with Ecopath/Ecosim.

The Ecosim/Ecopath/Ecospace suite of software is a powerful analytical tool because it can produce results even if only sparse data are available. When used by skilled and knowledgeable operators, this characteristic will represent an impressive advantage. However, it may become a liability when novice and/or unskilled users utilize the approach with inappropriate data or with improper assumptions. It would therefore seem reasonable to encourage training in the use of the approach. Moreover, it would be prudent to associate the principal developers in any advisory process making use of the methodology. It would take only a few misuses of the approach to permanently discredit the Ecosim/Ecopath/Ecospace suite with fishery management authorities.

## **Ecosim application to Lake Victoria**

**Jacques Moreau**  
*Ecole Nationale Supérieure Agronomique de Toulouse*

The introduction of Nile perch into Lake Victoria had an immense impact on the structure of that ecosystem. A previous contribution presented quantitative box models for two different periods in the history of Lake Victoria (Moreau et al. 1993). The first model, describing the late 1960s and early 1970s, emphasized the role of

haplochromine species in the Lake Victoria food web. The second model, describing the mid to late 1980s, showed the ecological importance of Nile perch as it became the dominant predator [Note that these describe only the shallow and intensively exploited Kenyan sector of the lake and thus do not apply to the lake as a whole].

This note describes some of the steps that were taken to adapt these previous models for use with Ecosim, and to test whether Ecosim can simulate the transition from the late 1960s situation to that prevailing in the late 1980s, thus complementing the account on Lake Victoria Nile perch in Walters et al. (1997).

Box 2 provides details on how the VICTOR85 file originally created by Moreau et al. (1993) was modified such that Nile perch could be treated as a split pool.

The results of the various runs then performed were as follows:

### **Equilibrium runs**

Except for a small labeling error immediately fixed by V. Christensen, this routine worked flawlessly. Its results confirmed the observation of Walters et al (1997) that the relationship of catch vs. fishing mortality is flat-topped for a wide range of fishing mortalities, thus suggesting a Beverton-and-Holt recruitment curve. Walters et al. (1997) suggest this to be due to the effect of adult Nile perch not only consuming juvenile Nile perch, but also the latter's competitors. By this, they increase the food available to the juveniles, thus increasing their growth rate and decreasing the time they spent in a vulnerable stage.

### **Simulation runs**

The runs were performed both with effort aggregated, and with total effort split into different gear, i.e., gill nets, mainly yielding large Nile perch and Nile tilapia (*Oreochromis niloticus*); longlines (for Nile perch and bottom fish of minor importance); beach seines (for juvenile Nile perch, tilapiine and haplochromines); and 'mosquito' nets (for *Rastrineobola*, small Nile perch and miscellaneous other species).

The runs with (aggregated) effort increasing over time generated unsurprising patterns of rapid decline in most groups, except for the tilapiines, which declined less than expected.

The responses of the various runs using effort disaggregated by gear types were too varied to be summarized here. Suffice to say that they were largely realistic, thus justifying the decision to make available, in Ecopath 4.0, a routine allowing such disaggregation. This is particularly true as

Ecospace now allows for spatial disaggregation of effort as well.

Indeed, this complements neatly the split-pool option of Ecosim, which has allowed overcoming the cannibalism almost invariably generated within groups that have piscivorous adults.

This leads to the notion that functional groups in the Ecopath suite should be defined by: (1) one food type; (2) one habitat type; (3) one gear type. This would perhaps resolve the issue of dynamic stability raised by Pauly (this vol.), and discussed in Watson and Pauly (this vol.).

Further, one way to reduce the resulting proliferation of functional groups would be to combine the prey groups contributing less than 1% to the diet of major predators, especially if these groups also contribute little to the fisheries catches.

The other suggestions I have concerning consideration of habitat changes are similar to those of Astrid, and hence I refer to her contribution (Jarre-Teichmann, this vol.).

### **Box 2 Inputs required to turn Nile perch into a split pool.**

The maximum size of the juveniles was assumed to be 40 cm, the length at which they tend to escape predation by adults (see Ogari and Dadzie, 1988); also their feeding habits at that size begin to resemble those of the adults. Note that up to this size, young Nile perch are observed mostly in the littoral areas of the lake (Hughes, 1986), and that 40 cm TL is the minimum size fish are caught by the gill nets fleet (at least in the mid 1980s).

The P/B ratio of the juveniles thus defined was estimated using the Compleat ELEFAN Software (Gayaniilo et al. 1989), based on length frequency distributions for the relevant range of sizes from Asila and Ogari (1987), and C. Rabuor (pers. comm). The estimate is 3.5 year<sup>-1</sup>. Q/B was estimated separately for the juveniles and adults using the MAXIMS software of Jarre et al. (1990), and parameters from Moreau et al. (1993) for the 85-86 period, viz.  $W_{\infty} = 76\ 000\ \text{g}$ ;  $K = 0.36\ \text{year}^{-1}$ ;  $Z = 0.85\ \text{year}^{-1}$ ;  $W_r = 2000\ \text{g}$ ;  $W_{\max} = 72\ 000\ \text{g}$ .

This led to  $Q/B = 5.03\ \text{year}^{-1}$ ; gross efficiency (GE) = 0.16, and 'beta' = 0.10 for the adults. The same inputs were used for the juveniles, except for  $Z = P/B = 3.5\ \text{year}^{-1}$ ;  $W_r = 25\ \text{g}$ ; and  $W_{\max} = 2000\ \text{g}$ , the last two values representing the lower and upper limits of the integration performed by MAXIMS. This led to  $Q/B = 11.8\ \text{year}^{-1}$  and  $GE = 0.29$  for the juveniles [Note that GE is higher for the juveniles than for the adults, in agreement with theoretical and empirical considerations (Pauly, 1986; Pauly and Palomares, 1987)].

The value for juveniles EE was set at 0.98, given the strong predation pressure on this group, while the diet composition for the juveniles and adults was adapted for data in Ogari and Dadzie (1988), and Hughes (1986), and considering the distinct spatial distribution of the two stages.

Ecopath 4.0, when balanced with Nile perch as a split group, generated biomass estimates nearly the same as presented in Moreau et al. (1993), where Nile perch was a single group.

## The Prince William Sound Model

**Tom Okey**  
**Fisheries Centre, UBC**

An Ecopath model of Prince William Sound (PWS), Alaska is being developed by Fishery Centre scientists through a collaboration of researchers with expertise in various components of the Prince William Sound ecosystem. The development of this model is funded through the Exxon Valdez Oil Spill (EVOS) Restoration Council, and thus will be somewhat focused on questions relating to the 1989 EVOS. A variety of researchers and research groups have been gathering information about the PWS ecosystem during the years since the oil spill, and some groups have developed models of certain portions of the ecosystem (Dalsgaard and Pauly, 1997). A great deal of information has been collected, but the overall EVOS research program has been recently criticized for producing a small amount of useful information relative to the amount of money spent to date (Paine et al, 1996). As a result, program peer reviewers are calling for initiatives that will synthesize the information collected thus far. The Fisheries Centre, in collaboration with the University of Tennessee (specifically Dr. Stuart Pimm), is now leading the ecosystem synthesis efforts based on the suggestion that the Ecopath approach is well suited for accomplishing the sort of synthesis desired by EVOS program architects. However, a variety of other benefits and applications may be derived from the Ecopath approach such as answering questions related to fisheries exploitation in the region.

### Ecopath and Ecospace

I am particularly impressed and excited about the new Ecospace component of the Ecopath package because of the additional realism it introduces to the work with Ecopath.

Organisms do not interact homogeneously in space or time. Furthermore, spatial refugia enable increased prey presence or persistence in the real world, while concentrating interactions in space. Top-down and bottom-up effects are probably both important in ecosystems, but refugia can be thought of as a 'third effect' that plays a crucial role in structuring communities, shaping the interactions within these communities, and enabling stability, whether these refugia are biotic or abiotic. With this in mind, it seems silly to expect realistic predictions or simulations from models that are not spatially explicit. The new Ecospace enables food-web simulations within a spatial and habitat con-

text. Although it is still unclear to me just how accurately current Ecospace models can represent real world interactions, given current constraints on desktop computing power, it is clear to me that a framework for such realistic modeling exists within Ecopath with Ecosim and Ecospace, and that this is a breakthrough.

Figure 12 illustrates a coarse-gridded spatial representation of the Prince William Sound, as required by Ecopath. This representation consists of a 31 x 36 square grid in which PWS land and water have been defined. This diagram was created by overlaying position-referenced grid-lines over a map of Prince William Sound, and it has been transferred into the Ecospace grid system for analysis of PWS data. At the PWS Ecopath Workshop held on March 2-5, 1997, in the EVOS Restoration Council office in Anchorage, this map led to a fierce debate about the spatial resolution of Ecospace, due to the sound's extreme geographic heterogeneity relative to the diagram. However, since the grid is used for distributing trophic interactions during model runs rather than for estimating input parameters, the method does nothing but heighten realism relative to alternative spatially homogeneous models.

Perhaps as important as the realism advances referred to above is the accessibility that Ecopath with Ecosim provides. Although it is helpful for front end users (those compiling site-specific models) to understand the underlying algorithms and processes, the concepts themselves are accessible to general users as a learning tool. Indeed, Ecopath models can be used as an educational tool for school children of various ages, and even by fishery decision makers.

In any given management setting, however, a primary question is how to use this modeling approach to address existing dilemmas or questions. Before models are constructed, larger questions about goals must be asked. For example, is restoration to a previous desired state the main goal? Or is prediction of stock size trajectory in response to particular exploitation regimes a more important goal? Alternatively, is the goal to evaluate particular management or

conservation measures e.g. marine protected areas? These questions should influ-

ence aspects of research design and also determine whether historical models should be developed to compare to current models.

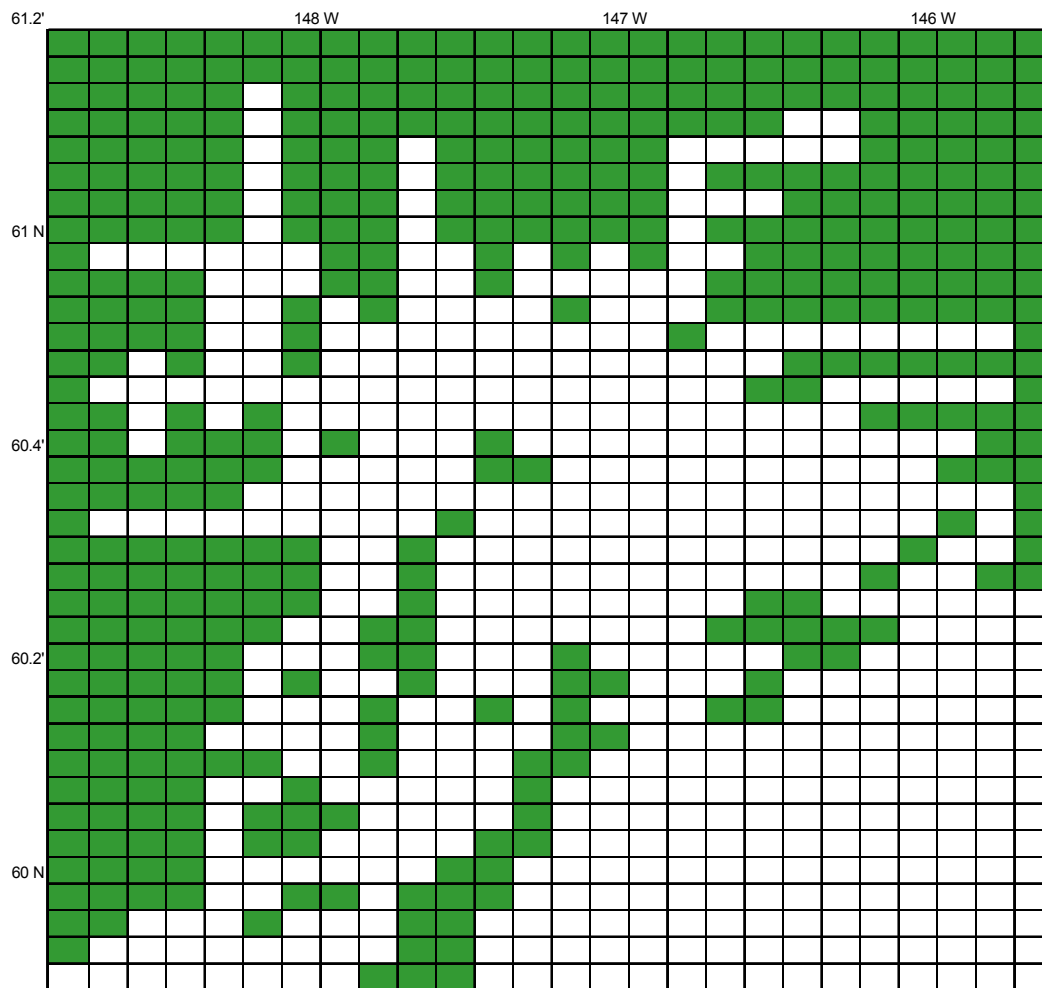

**Fig. 12** Coarse-grid map of Prince William Sound, Alaska, as created to apply Ecospace to that system. Note straightening of arms and coastlines, to allow unimpeded migration along uninterrupted series of grid squares (see text).

## **Modeling the Eastern Central Pacific Ocean**

**Robert J. Olson**  
*Inter-American Tropical Tuna Commission*

As a person with only modest familiarity with Ecosim, my participation in the workshop was primarily a learning experience. I am preparing to lead an effort at IATTC to assemble an Ecopath model for the eastern tropical Pacific Ocean (ETP) to explore the ecological implications of three different fishing strategies currently employed by the tuna purse-seine fishery. In the ETP, the top levels of the food webs consist of large tunas, dolphins, sharks, billfishes, and others. The purse-seine fishery targets yellowfin tuna, but substantial catches of other apex predators also occur. The species composition and magnitude of the associated by-catch, and the size-age distribution of the yellowfin catch, are distinctly different for the three aggregation types and fishing strategies.

We intend to incorporate historical and recent data from the ETP into Ecospace. We will work closely with Chris Boggs, NMFS Honolulu, and Jim Kitchell, University of Wisconsin, who are developing an Ecosim model for the Central North Pacific (CNP; see Kitchell, this vol.).

During the workshop I examined two models, the latest version of the CNP model, and the Central South China Sea model, distributed as a test file (OCEANSCS) with Ecopath. I tried, with mixed success, to split the apex-predator pool and to add sharks as a functional group. That exercise provided me a quick lesson on the component requirements for mass-balance. The CNP model provided me a pertinent system to manipulate because it has similar components to the pelagic ETP. Jim Kitchell and I made simulation runs in Ecosim and Ecospace that provided interesting results. J. Kitchell tried a hindcasting of sorts by ratcheting down fishing effort to correspond to the onset of the Asian longline fisheries after the Second World War. That exercise showed that yellowfin tuna biomass prior to fishing was 3-fold the current biomass, which was the same equilibrium for yellowfin biomass predicted at zero fishing mortality using the equilibrium routine in Ecosim. This was an encouraging result. Then, using the appropriate routine of Ecospace, I 'sketched in' the Central and South American coastline (although I did not re-scale the grid properly) and added the high-productivity zone associated with the upwelling caused by the eastern boundary currents. I also associated fishing with that zone. The predators aggre-

gated fast to the zone and had drastic effects on the ecosystem. The exercise convinced me that Ecospace represents a useful tool to simulate the food web impacts resulting from the different fishing strategies in specific regions within the eastern Pacific.

I am not yet convinced that Ecosim provides sufficient certainty about the system, at least with some system types. The biomass and life history characteristics of many components of open-ocean systems are virtually unknown. However, my skepticism has decreased, and as my limited experience with the model grows, I believe my confidence in the model will solidify.

## **Ecopath, Ecosim and evaluating policy in an ecological context**

**Ana Parma**  
*International Pacific Halibut Commission*

My impressions about the potential of Ecopath-Ecosim/space as a tool for developing harvesting strategies are largely based on what I learned during the workshop. I did not have any prior experience dealing with Ecopath, and I have little experience in ecosystem modeling. My background is on assessment and management of single species, and the focus of my research has been on developing assessment and harvesting strategies that are robust to the major uncertainties we face in fisheries management.

To address the basic question posed at the start of the workshop, there are two components of Ecosim that I would like to discuss separately: the component dealing with the ecology of the system; and the component dealing with the policies that can be evaluated.

The policy component:

The policies that Ecosim is readily set up to evaluate are harvesting policies, that is, policies that regulate the gear and amount of harvest of the different harvestable stocks in the system. The development of Ecospace expands the range of choices considerably, as spatially explicit policies can now be assessed without having to resort to pseudo-spatial models. This still excludes some very important approaches for management of multi-species resources, i.e., policies that involve manipulating the habitat, and policies that attempt to modify the behavior of the fishers through individual incentives and/or penalties. The latter may be the only way to manage industrial fisheries on multi-species assemblages. Getting to exploit the most productive species without overfishing the less productive ones may involve a selective allocation of effort in space at a spatial resolution much smaller than we can hope to achieve by quota-by-area management.

I am, however, not too concerned about the policy aspect. First, the limitations are obvious and so there is little danger of them being overlooked. Second, considering the speed at which the approach has evolved over the last few years, I would expect the policy component to be rapidly expanded, especially considering the range of possibilities opened by Ecospace.

The ecology component:

In contrast to the situation with policy evaluation, the limitations of the ecological basis of the model may not be so apparent to the users. The risks of the users 'believing' model predictions is real no matter how loud and clear the developers of the model may state that the tool is not intended to produce detailed ecological predictions. This is unfortunate, because Ecosim/Ecospace may be a great tool to have if one is clear about its limitations.

as a tool for helping in the design of adaptive policies and monitoring schemes, for constructing scenarios for policy evaluation, for generating qualitative predictions as a way to validate some of the underlying ecological hypotheses which have strong management implications, and for challenging I am very impressed with Ecosim/Ecospace ideas and expectations. One of the things I heard repeatedly over the workshop was that people were often surprised by the results, which is good.

The problem of believing model projections is certainly not exclusive to Ecosim. However, I tend to think that it may be worse here than in other models in which uncertainty is more ap-

parent. While Ecopath, through the Ecoranger routine, has a way to translate input uncertainty into output uncertainty, much of that is lost in the transit to Ecosim. This, of course, need not be the case. Users could generate many different projections from the Ecoranger posterior distribution, but I suspect the tendency will be to base all analyses on the 'best' Ecopath model. The power of Ecopath/Ecosim is that you can build models with very limited data, thanks to the mass-balance assumption. But to understand better the strengths and limitations of the approach, we will need the collective experience from those that use Ecopath in data-rich situations, where there is enough information to contradict model predictions and to drive model development. For example, one of the limitations of the approach is that the equilibrium assumption may lead to parameter estimates that are wrong and misleading. This could be explored by varying the biomass accumulation of the Ecopath master equation using available information on population trends in data-rich situations.

My impression is that as we are just starting to see Ecosim applications, there is still much to learn about model development from data-rich situations. The only way to take advantage of this powerful tool is to understand its weaknesses and explore them. Thus, endorsement of Ecosim as a tool for policy design should be very explicit about the limitations of the approach.

## **Improving food web descriptions of use in dynamic simulations**

***Daniel Pauly***  
***Fisheries Centre, UBC***

Use of food webs as a key input for time- and space-structured simulations imposes more constraints on their quality than their use in the context of Ecopath proper, which does not consider their stability in a dynamic context, and only requires them to be mass-balanced.

Following discussions with various colleagues, notably Stuart Pimm, of the University of Tennessee, I would like to suggest that food webs prepared for use in Ecosim and Ecospace should have the following properties:

1. at least 20 'boxes' (i.e., 'pools', or state variables) representing all major groups and trophic levels;
2. cannibalism should be avoided, or at least not contribute more than 1-2 % of a group's diet. This can be achieved by disaggregating groups into split pools (i.e., juveniles and predators, see Walters, this vol.), or into separate functional groups, of which one is the predator, the other the prey;
3. cycles must be avoided wherein group *i* feeds mainly on group *j*, and group *j* mainly on group *i* (use the 'Cycles' routine of Ecopath to identify such groups);
4. the base of the food web (primary producers, e.g. phytoplankton or seagrass, etc., and herbivores, e.g., zooplankton) should be separated by habitat within the ecosystem that is being modeled, e.g., inshore vs. offshore, or rocky bottom vs. mud bottom (Fig. 13).

Consideration of these four points will not resolve all problems that may be generated by a questionable food web; however, some pathological behaviors will be avoided, and the models, when run with Ecosim and Ecospace, will not self-simplify as readily as when these suggestions are not implemented.

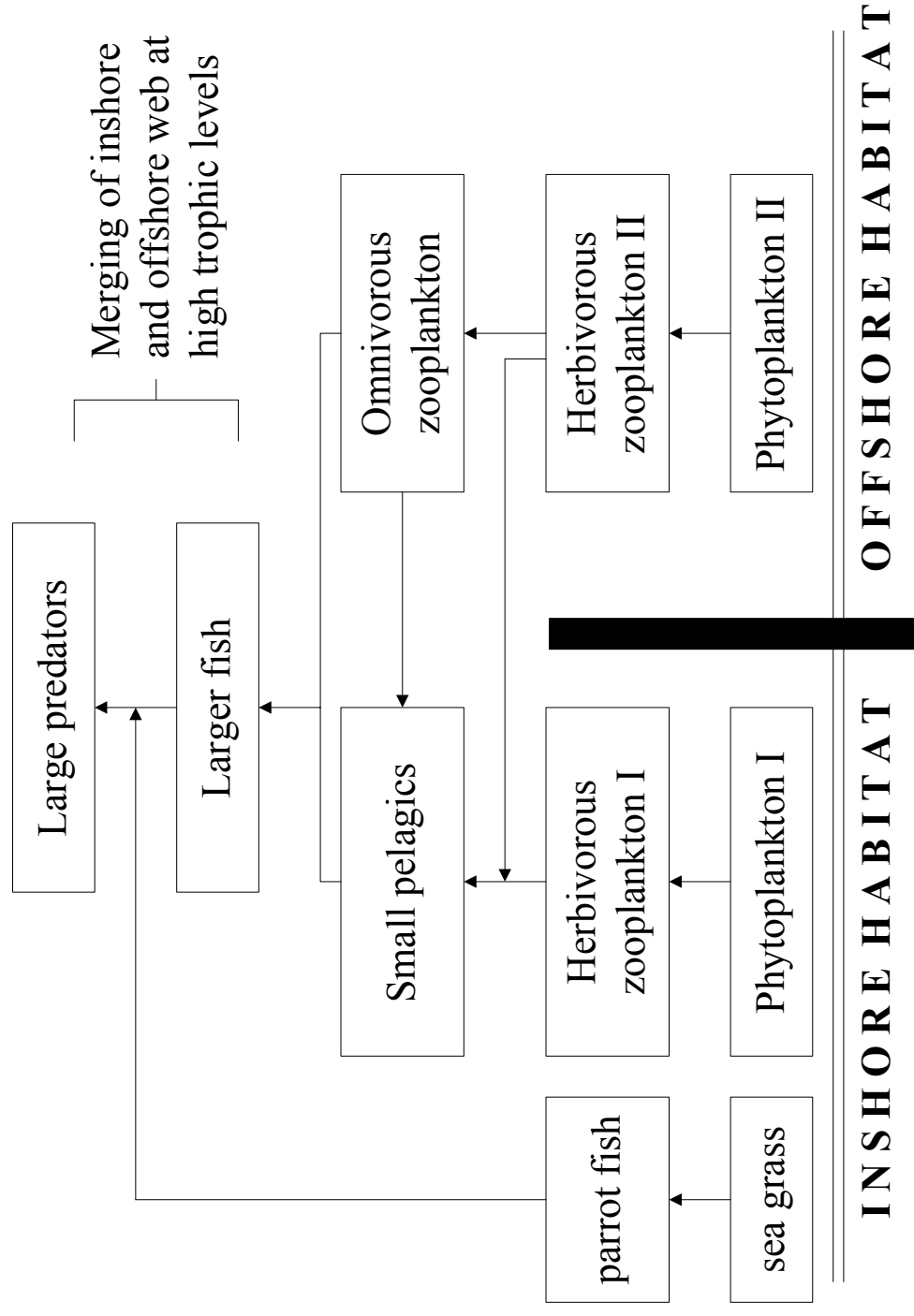

**Fig. 13** Example of a food web incorporating subsystems at lower trophic levels, i.e., inshore and offshore subsystems. Such separation leads to more realistic predictions by Ecosim, and facilitates the assignments of different groups to habitats, as required by Ecospace

## DISCUSSION

---

### Policy Uses and Limitations of the Ecopath Suite and Approach<sup>a</sup>

**Reg Watson**  
*Fisheries Dept., Western Australia*  
**and**  
**Daniel Pauly**  
*Fisheries Centre, UBC*

This report documents a free-ranging discussion on issues raised during the workshop, structured by Carl Walters, who acted as facilitator. Specifically, this involved grouping the predictions of Ecosim/ Ecospace into three classes: 1) predictions which can be trusted; 2) predictions, that require local testing/verification; and 3) predictions which, for various reasons, cannot be trusted.

Discussants are identified by their initials, and their interventions were regrouped and edited, thus making our discussion look more formal than it was.

#### 1. Predictions that can be trusted.

**CW:** concerning predictions, there are two that are fairly robust:

- primary production limits possible total production, through it will not determine whether a system is stable or not. Here, Ecopath and its dynamic routines, Ecosim and Ecospace can help;
- equilibrium community composition responds to fishing: as you alter fishing mortality, a number of changes in abundance are predicted. Notably, the system will tend to become top heavy when fishing is very low. Conversely, at very high fishing mortalities, long-lived species will be lost, while the changes at intermediate level of fishing mortality are largely indeterminate, i.e., we cannot assess their reliability. In fact some of the results for intermediate levels of fishing are goofy, with several stable states of which we don't know if they are realistic or not. But the extreme predic-

tions are reliable, including e.g., prediction of cascades.

**DP:** If so, one should be able to say that first-order predictions are largely reliable: groups that are exploited decline, and their major prey increase. OK?

**CW:** Yes, furthermore, we found, in some cases, that the fishing mortality which maximizes yield is much smaller than  $M$ , in some others it is larger. Gulland's rule, that  $F_{max} = M$  is #@%!!.

**TP:** How do you explain these differences? Perhaps we should stick to the most conservative relationship between  $F_{max}$  and  $M$ .

**KC:** We certainly need policies that are robust to uncertainty of this sort.

**DP:** Not only do we need to be cautious about the value of  $F_{max}$ , but also about the absolute value of the predicted yield. The point here is that in the 'development decades' of the 1960s and 1970s, what was done in several countries, notably in Southeast Asia, was to divide the catch of a typical trawler into the yield potential predicted by Gulland's equation, then deploy the number of boats that came out of the division.

**TP:** Does Carl's point about goofy results being obtained at intermediate levels of  $F$  imply that that our ecosystem work is worthless, or no better than single species assessments?

**KC:** We should do both type of work, as there is enough overlap for both to benefit from the other's results. We should also benefit from attempts to explain the causes of observed differences.

**TP:** If there are differences, we cannot say both sets of results are valid. Moreover, industry will also go against the more conservative results which tend to come out when you consider feeding interactions.

**DP:** In fact, you get a reduction of predicted yields in multispecies situations even when you don't consider feeding interactions; all you need is fixed ratios of  $F$  between the different species, as often occurs with trawlers. John Pope showed that very nicely in a study he did of the Gulf of Thailand trawl fishery. Incidentally, this is the very reason why we lose large, long-lived bycatch species.

**CW:** Trophic models cannot really provide practical answers to multispecies management problems.

**TP:** Then how about Multispecies VPA, which is used in Europe?

**DP:** They have made real progress with that in the North Sea, even if they don't use it directly to determine TAC for the various species. What they do is use MSVPA to refine the inputs to the single species assessments, e.g. the  $M$  values

---

<sup>a</sup> Present during the discussion were E. Bucharý, A. Bundy, V. Christensen, K. Cochrane, F. Gayanilo, A. Jarre-Teichmann, J. Kitchell, J. Moreau, T. Okey, R. Olson, D. Pauly (Editor), T. Pitcher, A. Pongase, R. Sumaila, C. Walters (Facilitator), and R. Watson (Rapporteur).

used for young fishes, which are now set much higher than before.

**KC:** But there are still uncertainties; for example, the relationship between sardine and anchovy in upwelling system is competition, but this cannot be captured by trophic interactions. This creates huge uncertainties.

**TP:** Yes, but adaptive management, including 'pushing the system' is hard to sell as a way to find out more. Multispecies/ ecosystem models should be inherently more predictive than single-species methods. In addition to predictions of the type provided by single-species models, they make predictions which single-species models simply cannot make. We have to get people used to these kinds of predictions.

**CW:** I agree that we can make broad predictions. We can predict that prey fishes will be affected if we remove their prey. This is not what some people want, though. What they want are detailed predictions of precisely what the biomass of each group will be next year. And this we cannot do. Let's move on to another category of predictions, concerning the efficacy and time requirements for transition policies. This involves, among other things, estimating what it takes for experimental programs, etc. to work. Some policies will never show effects, e. g. the setting up of very small MPAs.<sup>d</sup>

**DP:** In Alaska, the Exxon Valdez Oil Spill Restoration Council must certify whether the various elements of the Prince William Sound ecosystem have bounced back or not. We are now working on that using a consensus Ecosystem model as our starting point (see Okey, this vol.). In the oiled area, the slow groups (marine mammals, birds) have not returned to pre-spill levels, and I expect we will be able to find this to be the aftermath of a shock to the food web, i.e., there might be no need to assume continued effects of oil residues.

**KC:** I have a related question: what do you monitor in multispecies management, and how is the monitoring done?

**CW:** We should monitor F directly, by tagging everything.

**KC:** All species?

**CW:** All species that need direct monitoring. Estimating F is important because multispecies problems are due to the effects of a combination

of gear, and attempts at effort reduction must not be limited to one gear. Multispecies problem occurs when one gear is cut back and other gears move in, like the sport fishery, and cause new problems.

**JK:** We should be testing for the effects of keystone species, and for effects caused by feeding triangles such as the Norway pout-euphausiids-copepod case that Villy Christensen presented (in Pauly et al. 1998). Alida Bundy's analysis of San Miguel Bay dynamics, where species interactions appear to be very strong is another case (Bundy, 1997).

**CW:** We will just have to accept that some type of changes is just not predictable. Also, we must be aware that Ecoranger can deal only with some types of uncertainties; it cannot deal with the uncertainty associated with the equilibrium predictions of Ecosim, which are due to the structure built into the systems' description. Anyway, let's now turn to our next topic.

## 2. Predictions that need local testing.

**CW:** As mentioned before, there are some complex webs for which the outcomes of Ecosim are indeterminate, i.e., the directions of response to gear changes can go either way. A case in point is Alida's model of the heavily exploited San Miguel Bay, where clear predictions could not be achieved for most groups, given policy changes. This is particularly pronounced for the intermediate trophic levels, while the top and lower levels behave as one would expect.

**DP:** This might be due to overaggregated pools at intermediate levels, with diet compositions that are too broad.

**CW:** It is true that, with overgeneralized piscivores, problems will occur, but Alida's mid-trophic level pools were not that generalized.

**DP:** Our partner in the Prince William Sound project, Stewart Pimm, says that overaggregated lower trophic levels are the main cause of instability and self-simplification in food webs, and that this is the first thing one should look for when problems occur; also feeding cycles between pools at the same trophic level should be avoided. Stuart said he is working on a diagnostic system, later to be incorporated into Ecopath, which will identify these problems (see Pauly, this vol.).

**CW:** This has been known a while; but this will not resolve the problem of indeterminacy in the intermediate trophic levels.

**KC:** In upwelling systems, notably in the Benguela system, sardine vs. anchovy competition is not well understood and is not predictable.

---

<sup>d</sup> Editors note: I can't resist pointing out here that some people believe (indeed: have shown) that very small MPAs can increase the biomass of relatively large, potentially very mobile fish, such as parrotfishes and snappers. See C.M. Roberts and J.P. Hawkins. 1997. How small can a marine reserve be and still be effective? *Coral Reefs* 16:150.

Note that this is a general problem of lack of knowledge, not a problem with Ecopath.

**CW:** People working on coral reefs think partitioning is the key problem to study, because it is what maintains reef diversity. Space, not food is the problem they focus on.

**DP:** I don't agree that it is their consensus. In fact, many of them, especially in Australia, believe recruitment limitation and variability to be the major structuring elements for coral reefs. In any case, don't we agree that space being important, we should construct food webs with subwebs referring to different parts of one's system, and especially separate the phyto- and zooplankton groups?

**CW:** This is unnecessary, and probably wrong; there are better ways to achieve stability.

**TO:** I believe it is wise to follow Pimm's advice; we are including over 40 groups in the Prince William Sound model we are constructing to analyze the impact of the Exxon Valdez Oil Spill (Okey, this vol.), and use these to define well-separated inshore and offshore webs, merging only at the top.

**VC:** Another way to generate stability is by using low movement rates in Ecospace; this leads to clear spatial separation.

**CW:** Space-structured models can allow co-existence of about anything at some scales, and prevent self-simplification of food webs.

**DP:** I still think Pimm's suggestions are useful, especially since they generate food webs whose subwebs correspond to the very spatial structure that you say is required.

**CW:** Even if you follow Pimm's suggestions, some webs will still self-simplify; there are many cases where we don't know what keeps the system stable. Clearly, spatial separation plays a role at some scales, but this is not the whole story. There are key processes we still do not understand. Even Villy's detailed Ecopath model of the North Sea is not stable when run on Ecosim.

**KC:** We have to avoid the reductionist trap, and not get into an endless process of digging deeper and deeper and never getting to the key process; clearly each model we use must fit specific circumstances.

**DP:** If we match our spatial separation with our food web, we should be OK. The point is to avoid the bias we have as fisheries people, to lump zooplankton and phytoplankton into great big boxes, because we don't know about them – though the planktologists do.

**CW:** Sub-models may be the answer, with linkages at the top, e.g. through the marine mammals feeding in the different sub-models.

**DP:** This is what has been done, in effect, in some of the coral reef models that have been

published so far. There, subsystems were defined (sea grass, lagoon, crest, slope) and linked by groups that feed in two or more of the subsystems. In fact, I believe we should return to the Ecopath models that do not include this type of structures, and fix them before we use them for spatial modeling.

**VC:** Let's be cautious before we make such changes; first we must check that they really do what Pimm says they do.

**CW:** I checked the number of pools in Ecopath models vs. the maximum value of the vulnerability multipliers that could be accommodated without self-simplification of the food webs, which more or less corresponds to S. Pimm's test of stability. There was a general trend toward loss of mid-trophic level pools, except in models with very detailed diets. Medium-sized models were unstable.

**DP:** Pimm's routine will do more or less the same thing, for any model we want to analyze, as a part of the Ecopath diagnostic system.

**CW:** The way to go about this problem of stability is not necessarily via better ecology, but through a better look at the policy questions and the inherent credibility of answers.

**KC:** Some will want to assure themselves that the ecology included in their model is as good as possible.

**VC:** Certainly users should check for cycles in their models. This can be done easily using a routine of Ecopath.

**KC:** But we don't want a cookbook either, or people mindlessly generating numbers. Better perhaps to have a number of guidelines, such as Carl's check of the effect of changing the vulnerability schedules.

**DP:** But some of the guidelines we teach to Ecopath users do have cookbook character, e.g., 'avoid cannibalism', 'do not include less than 12-15 boxes spread over the whole food web', etc.

**CW:** Let's now move to the third group of predictions.

### 3. Predictions that cannot be trusted.

**CW:** The biggest question we have is that relating to animals with trophic changes during their life history. We have tried to resolve this through split pools, but generally, these split pools, in Ecosim, tend to predict too much compensatory change. This is disappointing. It could be due to a failure to describe the factors affecting survival or changes in life history, etc.

**JK:** Behaviour is context dependent, and rules should not be inflexible. One useful rule though is that the P/B value tells us how fast unex-

pected things can happen; groups with low P/B cannot change as fast as others.

**KC:** I can imagine, that there might be policy situations in which it would help to distinguish more than the two size/age groups presently allowed as 'split pools' in Ecosim.

**CW:** I don't believe having more size/age groups would make much of a difference. Besides, the data and computational requirements would be so enormous, we would lose all present advantages of the package. In any case, it would be very difficult to have a highly detailed size/age distribution consistent with the rest of Ecopath/Ecosim/Ecospace. In fact even our present, relatively simple representation leads, through various amplifications, to highly complex behavior, e.g., in the case of Jim Kitchell's model of the Central Pacific. Another source of problem is when we use the time-shapes in Ecosim to represent changes in productivity.

**DP:** If we build models without physical forcing, we can't well introduce such forcing through the back door, as it were, and expect it to work well.

**VC:** Yet we do that with the economic component, and it appears to be of some use.

**KC:** Is it really true, Carl, that these predictions are completely "hopeless"?

**CW:** They are 'just so stories' and cannot be validated. Just like the various empirical models that link recruitment and some environmental parameter, which all break down the year after they are published.

**DP:** Seems to me that the Cury-Roy (Cury and Roy, 1989) hypothesis of dome-shaped recruitment windows did not break down. In fact, it has so far survived every test to which it was put.

**TP:** Could not the 'time shaping' in Ecosim be replaced by a proper, if somehow generic oceanographic model to simulate production at the lower trophic levels?

**DP:** The folks working on Prince William Sound have a good physical model, which nicely predicts phytoplankton blooms, the growth of the zooplankton that feeds on it, and the effect on the juveniles of some fishes. The problem is that they cannot put the system higher up in the same modeling framework. Thus, they cannot deal, e.g., with killer whales.

**TP:** Something like that would make lots of sense in Peru and other upwelling ecosystems.

**DP:** Such model would make sense there, as not much of interest to the fishery happens at the highest trophic levels, now that the birds, etc. are gone.

**VC:** Clearly, a model must respond to a specific need for predictions.

**CW:** Exactly; in our Grand Canyon work, we must model things on an hourly basis, because this is the scale at which interventions (water releases) happen, and most of the ecological impact flows from there.

**KC:** Can we not use Ecoranger to deal with some of the uncertainties here?

**JK:** I don't think so; the uncertainty is the structure of the system itself, so the true uncertainty will not be captured by a sensitivity or Monte-Carlo analysis of an existing model.

**DP:** So we delude ourselves when we use Ecoranger to define prior distribution, generate 'random' models, look at the posterior distributions, etc?

**JK:** It's like painting with a broad brush. It gives a broad picture; whether this is 'real' or not is another question. Perhaps it is 'halfway' correct.

**CW:** This makes me think of these various estimates of speed of light: all had confidence intervals about them. Yet the next estimate was invariably outside of the interval. This is similar to ecosystems, where qualitatively new behaviors emerge which are outside of the range of prediction of previous models.

**DP:** In Ecoranger, we can resample not only parameters such as biomass, P/B ratios, etc, but also the diet compositions. This means that by randomly generating new linkages between groups (where such linkages are possible), we can, in principle generate new system behaviors. However, nobody has used this routine to that end yet.

**KC:** So we all agree that model uncertainty cannot be overcome, but that Ecoranger is useful, in that it provides a measure of the minimum amount of uncertainty one has to accept in a given model.

**VC:** I certainly agree with that. Indeed, Ecoranger has now been accepted by lots of colleagues who previously were critics of the Ecopath approach.

**DP:** This should conclude our debate of Carl's three types of predictions. Let's now briefly talk about what comes next. For one, Ecospace will be presented at the next annual ICES Science Conference, in Portugal (see abstract in Walters, this vol.). Also, Ecosim and Ecospace will now be incorporated as elements of the Ecopath training courses to be given in the context of a large international project funded by the European Commission. Perhaps I should ask Villy to briefly describe this.

**VC:** The project Daniel just mentioned is called "Placing fisheries in their ecosystem context". It involves 31 institutions in Europe, West and South Africa, the Caribbean and Latin America as partners. It is the intention over the next 4

years to arrange a number of training workshops and conferences aimed initially at developing Ecopath models, and next on comparing published Ecopath models across latitude, degree of exploitation, and so on. Colleagues interested in the activity are very welcome to contact me for details.

**DP:** Then there is the conference, sponsored by IOC/SCOR's Working Group 105, and ICES, on the Ecosystem Impacts of Fisheries, to be held next year in Montpellier. I should chair its session on 'Trophic Impacts'. My own contribution to that will probably be to review the trophic level concept, so important in Ecopath.

**VC:** There is also the FAO-sponsored workshop to which the present workshop was the preparation. I think this should be organized like an ICES working group, and involve very knowledgeable colleagues, willing and capable to perform a systematic examination of the features of key predictions.

**TP:** This will require a more formal structure than we had during this workshop, with steps clearly outlined beforehand.

**KC:** I agree. Indeed, there should be dummy policies for people to test, resembling those which are usually evaluated.

**AP:** Recently, the U.S. National Research Council released a report on methods for fish stock assessment in which the methods were all applied to a dummy data set.

**VC:** The participants, if from the ICES area, will need data sets which enable comparisons between the outputs of Multispecies VPA and those of the Ecopath suite. They might otherwise not be interested.

**KC:** But real Ecopath users will also be needed.

**TP:** Experts having experience with other methods are important, lest the workshop might be preaching to the converted. The NRC approach that Daniel mentioned might be best, as it introduces a degree of objectivity in the evaluations.

**DP:** So what do we conclude for this workshop?

**RS:** If we can trust the type of predictions Carl identified as trustworthy, then we should be in good shape.

**AP:** But we need more than Carl's opinion.

**CW:** Here it comes, nevertheless: one thing we will have to watch is the possibility of bugs as explanation for some of the strange patterns we got with split pools. But in any case, we should not give too much attention to time transient patterns. Generally, I am not surprised by our results, which are mostly O.K.

**JK:** When split pools gave us problems, we assigned the two stages to separate 'species'. This helped. Another observation I have is that the MPA scale determined by Ecospace seems

to work, and can be used to screen policies and eliminate bad thinking about economic trade-offs.

**KC:** My comment about the workshop as a whole is that I'm happy with the way it went, and with its results.

**JK:** I can only recommend that the software now be made ready for beta testing by as many users as possible, so its remaining bugs can be ironed out. Then, let's organize blind round robins for further definition of its capabilities, as suggested before. The software will then grow and reach its potential.

**VC:** We will do that. We would be thankful if people sent us detailed bug reports, which we will fix in the version that can be downloaded from the Web. The address from which to download Ecopath is [www.ecopath.org](http://www.ecopath.org), or you can contact me at [v.christensen@cgnet.com](mailto:v.christensen@cgnet.com).

**AB:** Will there be a separate user guide, as for the DOS version, or an online guide, as for version 3.0 and 3.1?

**VC:** The beta test version, to be distributed some months from now, will have an online guide, updated from that in version 3.1. This workshop and some others we ran provided ideas as to what to add to the available material. We will have to reverse-engineer a few parts of the text, based on the routines we now have, and their documentation in the primary literature.

**KC:** This has been a very successful workshop and I thank Carl and Villy for their contributions and Daniel and Gunna for the workshop organization. Far more has been achieved than I anticipated, and I can see that we now have a useful tool at hand, which will make it to possible for critical 'what-if' questions to be asked in a multispecies spatial context, without the big guns who developed Multispecies VPA having to be consulted. Making this power widely available will be very valuable. I'm very happy and learnt a lot and am looking forward to the final report soon.

**DP:** We thank you and FAO for having made this possible. We are quite proud that such an important player as FAO expressed interest in the work done at the Fisheries Centre; I would like to thank Gunna for her help with the workshop preparations and Carl Walters, for the fascinating lectures, and for having turned the Ecopath suite into the dynamic tool it now is. Finally, I would like to thank those colleagues who came on their own, such as Jim Kitchell, to share their ideas with us.

## References<sup>c</sup>

- Anon, 1995. The Kyoto Declaration and Plan of Action. International conference on the sustainable contribution of fisheries to food security. Kyoto, Japan, 4-9 September 1995. Fisheries Agency, Japan. 21 p. [6]
- Asila, A. and J. Ogari.. 1987. Growth Parameters and Mortality rates of Nile perch (*Lates niloticus*), estimated from length-frequency data in the Nyanza Gulf (Lake Victoria). FAO Fish. Rep. 389:1272-287. [31]
- Bakun, A. 1996. Patterns in the ocean: ocean processes and marine population dynamics. Centro de Investigaciones Biologica del Nordeste, La Paz, Mexico/ University of California Sea Grant, San Diego, USA. [27]
- Bundy, A. 1997. Assessment and Management of Multispecies, Multigear Fisheries: A case study from San Miguel Bay, the Philippines. Ph.D. Thesis. University of British Columbia, Vancouver, B.C. Canada. 395 p. [39]
- Butterworth, D.S., Cochrane, K.L. and J.A.A. de Oliveira. 1997. Management procedures: a better way to manage fisheries? The South African Experience. In: E.K. Pikitch, D.D. Huppert and M.P. Sissenwine (eds.). Global Trends: Fisheries Management. American Fisheries Society, Symposium 20, Bethesda. [7]
- Christensen, V. and D. Pauly 1992a. Ecopath II - A system for balancing steady-state ecosystem models and calculating network characteristics. Ecol. Modeling 61: 169-185. [10]
- Christensen, V. and D. Pauly 1992b. A guide to the Ecopath II software system (version 2.1). ICLARM Software 6, 72 p. [10]
- Christensen, V. and D. Pauly 1995. Fish production, catches and the carrying capacity of the world ocean. Naga, the ICLARM Quarterly. 18(3): 34-40. [10]
- Christensen, V. and D. Pauly 1996. Ecological modeling for all. Naga, the ICLARM Quarterly. 19(2):25-26. [10]
- Cury, P. and C. Roy. 1989. Optimal environmental window and pelagic fish recruitment success in upwelling areas. Can. J. Fish. Aquat. Sci. 46: 670-680. [41]
- Dalsgaard, J. and D. Pauly 1997. Preliminary Mass-Balance Model of Prince William Sound, Alaska for the Pre-Spill Period 1980-1989. Fisheries Centre Research Report 1997, 5(2), 34 p. [32]
- FAO 1995. Code of Conduct for Responsible Fisheries. FAO, Rome. 41p. [6]
- Froese, R. and D. Pauly (Editors). 1998. FishBase 98, Concepts, Design and Data Sources. ICLARM. [9]
- Gayanilo, F.C., M. Soriano and D. Pauly. 1989. A draft guide to the Compleat ELEFAN. ICLARM Software 2, 65 p. [31]
- Haggan, N. 1996. Integration of Traditional Environmental Knowledge p. 88-89 In: D. Pauly and V. Christensen (eds.) Mass-Balance Models of North-eastern Pacific Ecosystems. Fisheries Centre Research Reports 4(1). [26]
- Haggan, N. 1998. Reinventing the Tree. p. 19-39. In: T. Pitcher, D. Pauly & P. Hart (Eds.) Reinventing Fisheries Management. Chapman & Hall. London. [26]

---

<sup>c</sup> The page(s) where each reference is (are) given in square brackets, and thus these references may be used as an authors' index.

- Hughes, N.F. 1986. Changes in the feeding habits of Nile perch *Lates niloticus* (L.) in Lake Victoria, East Africa since its introduction in 1960 and its impact on the native fish community of the Nyanza Gulf. *J. Fish Biol.* 29: 541-548.[31]
- Jarre, A., M.L. Palomares, M.L. Soriano, V.C. Sambilay, Jr. and D. Pauly. 1990. MAX-IMS: A computer program for estimating the food consumption of fishes from diel stomach contents data and population parameters. *ICLARM Software* 4 27 p.[31]
- Jarre-Teichmann, A. 1995. Seasonal mass-balance models of carbon flow in the central Baltic Sea, with emphasis on the upper trophic levels. *ICES C.M.* 1995 T:6.[27]
- Jarre-Teichmann, A., K. Wieland, B.R. MacKenzie, H.H. Hinrichsen, M. Plikshs and E. Aro. 1997. Stock recruitment relationship for Central Baltic cod (*Gadus morhua*) incorporating environmental variability. *ICES Symposium on the Recruitment Dynamics of Exploited Marine Populations: Physical-Biological Interactions*, 22-24 September 1997, Baltimore, USA. [submitted to *ICES Mar. Sci. Symp.*] [27]
- Jarre-Teichmann, A., L.J. Shannon, C.L. Moloney and P. Wickens. Comparing trophic flows in the Southern Benguela to other upwelling ecosystem. *South African Journal of Marine Science* (in press) [27]
- MacKay, A. 1981. The generalized inverse. *Practical computing*. September 1981: 108-110. [10]
- Moreau, J., W. Ligtoet and M.L.D. Palomares. 1993. Trophic relationship in the fish community of Lake Victoria, Kenya, with emphasis on the impact of Nile perch (*Lates niloticus*), p. 144-152. In V. Christensen and D. Pauly (eds.) *Trophic models of aquatic ecosystems*. *ICLARM Conf. Proc.* 26. [30,31]
- Munro, G. and U.R. Sumaila. 1998. Assessing the economic benefits of artificial reefs and marine protected areas in Hong Kong waters. In T. Pitcher et al. (eds) *Fisheries Centre Research Reports* (in press). [19, 20]
- Ogari, J. and S. Dadzie 1988. The food of Nile perch *Lates niloticus*, after the disappearance of the haplochromine cichlids in the Nyanza Gulf of Lake Victoria Kenya. *J. Fish. Biol.* 32, 571-577. [31]
- Paine, R.T., J.L. Ruesink, A. Sun, E.L. Soulanille, M.J. Wonham, C.D.G. Harley, D.R. Brumbaugh and D.L. Secord. 1996. Trouble on Oiled Waters: lessons from the *Exxon Valdez* oil spill. *Annu. Rev. Ecol. Sys.* 27:197-235 [32]
- Pauly, D. 1986. A simple method for estimating the food consumption of fish population from growth data and food conversion experiments. *U.S. Fish Bull.* 84: 827-840. [31]
- Pauly, D. and M.L. Palomares. 1987. Shrimp consumption by fish in Kuwait water: a methodology, preliminary results and their implication for management and research. *Kuwait Bull. Marine Sciences* 9:101-125. [31]
- Pauly, D. and V. Christensen. 1996. Mass-Balance Models of North-eastern Pacific Ecosystems. *Fisheries Centre Research Reports* 4(1) 131 p. [26]
- Pauly, D., V. Christensen, J. Dalsgaard, R. Froese and F. Torres Jr., 1998. Fishing down marine food webs. *Science* 279: 860-863. [21, 26, 39]
- Pitcher, T. and D. Pauly, 1998. Rebuilding ecosystems, not sustainability, is the proper goal of fisheries management. p. 311-329. In: T. Pitcher, D. Pauly & P. Hart (eds.) *Reinventing Fisheries Management*. Chapman & Hall. London. [21, 26]

- Pitcher, T.J. Fisheries management that aims to rebuild resources can help resolve disputes, reinvigorate fisheries science and encourage public support. In: Beckett (ed.) (in press a). [21]
- Pitcher, T.J. Rebuilding as a New Goal for Fisheries Management: Reconstructing the Past to Salvage the Future. In: Eck-schmitt, K. (ed.) *Managing Ecological Systems: Challenges, Successes and Failures*. John Wiley, NY. (in press b). [21]
- Polovina, J.J. 1984. Models of a coral reef ecosystem I: the Ecopath model and its application to French Frigate Shoals. *Coral Reefs* 3(1): 1-11. [10]
- Polovina, J.J. 1985. An approach to estimating an ecosystem box model. *U.S. Fish. Bull.* 83(3):457-560. [10]
- Polovina, J.J. and M.D. Ow 1983. *Ecopath: a user's manual and program listings*. NMFS/NOAA, Honolulu Admin. Rep. H-83-23, 46 p. [10]
- Roberts, C.M. and J.P. Hawkins. 1997. How small can a marine reserve be and still be effective. *Coral Reefs* 16:150. [39]
- Sumaila, U.R. 1997. Cooperative and non-cooperative exploitation of the Arcto-Norwegian cod stock in the Barents Sea. *Environm. Res. Econ.* 10:147-165. [19]
- Sumaila, U.R. Protected marine reserves as fisheries management tools: A bio-economic analysis. *Fish. Res.* (in press). [19]
- Ulanowicz, R.E. 1986. *Growth and development: ecosystems phenomenology*. Springer Verlag, New York, 203 p. [10]
- Walters, C., V. Christensen and D. Pauly. 1997. Structuring dynamic models of exploited ecosystems from trophic mass-balance assessments. *Rev. Fish. Biol. Fish.* 7, 139-172. 6, 11, 15, 30, 31]
- Walters, C., D. Pauly, V. Christensen and J. Kitchell. 1998. Representing density dependent consequences of life history strategies in an ecosystem model. *Eco-sim II*. (under review by CJAFS). [11]
- Walters, C., D. Pauly and V. Christensen. 1998. *Ecospace: a software tool for predicting mesoscale spatial patterns in trophic relationships of exploited ecosystems, with special reference to impacts of marine protected areas*. To be presented at Theme Session (S) on 'Visualization of Spatial (including Survey) Data', of the ICES Annual Science Conference, Cascais, Portugal, September 1998. [6, 11, 13]

# Appendix 1

## Workshop Schedule

March 25-27, 1997

Fisheries Centre, University of British Columbia

---

### Wednesday 25

09h30	Introduction by convener ( <i>Daniel Pauly</i> )
09h45	FAO's expectations for the workshop ( <i>Kevern Cochrane</i> )
10h00	COFFEE BREAK
10h30	Lecture on "Mass balance modelling and Ecopath, with emphasis on new features of Vers. 4.0". ( <i>Villy Christensen</i> )
11h30	On screen Ecopath demonstrations
12h00	LUNCH
14h00	Participants finalize their Ecopath 4.0 files, with particular attention to split pools (help provided by <i>Villy Christensen</i> , <i>Astrid Jarre-Teichmann</i> , <i>Daniel Pauly</i> and Fisheries Centre's students).
15h30	COFFEE BREAK

### Tuesday 26

09h00	Lecture on "Ecosim: opportunities and limits" ( <i>Carl Walters</i> )
10h00	COFFEE BREAK
10h30	Lecture on "Introducing bioeconomics into the Ecopath/Ecosim framework" ( <i>Rashid Sumaila</i> )
11h15	Basic analysis of Ecosim runs
12h00	LUNCH
14h00	Lecture on "Population embedding: scaling the strength of trophic interactions" ( <i>Carl Walters</i> )
14h45	Ecosim exercises with different levels of predator control
15h30	COFFEE BREAK
15h45	Lecture on "Ecosim and Marine Protected Areas" ( <i>Reg Watson</i> )
16h30	Lecture on "Spatial modeling using Ecospace" ( <i>Carl Walters</i> )
17h15	Ecosim (and MPA) policy exploration and start of writing up participants' observations.

### Friday 27

09h15	Lecture on "Back to the Future: an agenda for reconstruction of past ecosystems" ( <i>Tony Pitcher</i> )
10h00	Exercises with Ecosim and Ecospace
11h00	COFFEE BREAK
11h30	Further exercises and report writing
12h30	LUNCH
14h00	General Discussion: Ecosim/Ecospace predictions Rapporteur: <i>Reg Watson</i>
15h30	COFFEE BREAK
16h00	Workshop closure ( <i>Kevern Cochrane</i> and <i>Daniel Pauly</i> )

## Appendix 2

### List of Participants

**Aydin Kerim**

Fisheries Research Institute,  
University of Washington  
Box 357980  
Seattle, WA 98195, USA  
E-mail: kerim@fish.washington.edu

**Eny Buchary**

Fisheries Centre  
University of British Columbia  
Vancouver, B.C. V6T 1Z4, Canada  
E-mail: eny@fisheries.com

**Alida Bundy**

Groundfish Division  
Dept. of Fisheries and Oceans  
North West Atlantic Fisheries Centre  
PO Box 5667  
St. John's, NFLD, Canada  
E-mail: bundy@athena.nwafc.nf.ca

**Villy Christensen**

ICLARM  
MCPO Box 2631  
0718 Makati City, Philippines  
E-mail: v.christensen@cgnet.com

**Lorenzo Ciannelli**

School of Fisheries  
University of Washington  
Box 357980  
Seattle, WA 98195, USA  
E-mail: lorenzo@fish.washington.edu

**Kevern Cochrane**

FAO  
Via delle Terme di Caracalla  
100 Rome, Italy  
E-mail: kevern.cochrane@fao.org

**Johanne Dalsgaard**

Fisheries Centre  
University of British Columbia  
Vancouver, B.C. V6T 1Z4, Canada  
E-mail: johanne@fisheries.com

**Felimon Gayanilo**

ICLARM  
MCPO Box 2631  
0718 Makati City, Philippines  
E-mail: f.gayanilo@cgnet.com

**Nigel Haggan**

Fisheries Centre  
University of British Columbia  
Vancouver, B.C. V6T 1Z4, Canada  
E-mail: [nhaggan@fisheries.com](mailto:nhaggan@fisheries.com)

**Kathy Heise**

Dept. of Zoology  
University of British Columbia  
Vancouver, B.C. V6T 1Z4, Canada  
E-mail: heise@zoology.ubc.ca

**Leonardo Huato**

Fisheries Centre  
University of British Columbia  
Vancouver, B.C. V6T 1Z4, Canada  
E-mail: huato@fisheries.com

**Astrid Jarre-Teichmann**

Danish Institute for Fisheries Research  
North Sea Centre  
PO Box 101  
DK-9850 Hirtshals, Denmark  
E-mail: ajt@dfu.min.dk

**Jim Kitchell**

Centre for Limnology  
University of Wisconsin  
680 N. Park Street  
Madison, WI 53706, USA  
E-mail: kitchell@macc.wisc.edu

**Pat Livingston**

Alaska Fisheries Science Centre  
2600 Sand Point Way N.E.  
Seattle, WA 98115, USA  
E-mail: pat.livingston@noaa.gov

**Jean-Jaques Maguire**  
Halieutikos Inc.  
1450 Godefroy Sillery  
Quebec G1T 2E4, Canada  
E-mail: jj\_maguire@compuserve.com

**Jaques Moreau**  
INP / ENSAT  
BP 354  
F-31006 Toulouse, France  
E-mail: moreau@ensat.fr

**Tom Okey**  
Fisheries Centre  
University of British Columbia  
Vancouver, B.C. V6T 1Z4, Canada  
E-mail: tokey@fisheries.com

**Bob Olson**  
Inter-American Tropical Tuna Commission  
Scripps Institution of Oceanography  
8604 La Jolla Shores Drive  
La Jolla, CA 92037-1508, USA  
E-mail: rolson@iattc.ucsd.edu

**Ana Parma**  
International Pacific Halibut Commission  
PO Box 95009  
Seattle, WA 98145-2009, USA  
E-mail: ana@iris.iphc.washington.edu

**Daniel Pauly**  
Fisheries Centre  
University of British Columbia  
Vancouver, B.C. V6T1Z4, Canada  
E-mail: pauly@fisheries.com

**Tony Pitcher**  
Fisheries Centre  
University of British Columbia  
Vancouver, B.C. V6T 1Z4, Canada  
E-mail: tpitcher@fisheries.com

**Rashid Sumaila**  
Fisheries Centre,  
University of British Columbia  
Vancouver, B.C. V6T 1Z4, Canada  
& Chr. Michelsen Institute, Bergen  
E-mail: sumaila@fisheries.com

**Andrew Trites**  
Fisheries Centre  
Marine Mammal Research Unit  
University of British Columbia  
Vancouver, B.C. V6T 1Z4, Canada  
E-mail: trites@zoology.ubc.ca

**Marcelo Vasconcellos**  
Fisheries Centre  
University of British Columbia  
Vancouver, B.C. V6T 1Z4, Canada  
E-mail: marcelo@fisheries.com

**Scott Wallace**  
Resource Management and Environmental  
Studies  
#436E, 2206 East Mall  
University of British Columbia  
Vancouver, B.C. V6T 1Z3  
E-mail: sscott@unixg.ubc.ca

**Carl Walters**  
Fisheries Centre  
University of British Columbia  
Vancouver, B.C. V6T 1Z4, Canada  
E-mail: walters@fisheries.com

**Reg Watson**  
Fisheries Western Australia  
PO Box 20  
North Beach, Australia 6020  
E-mail: rwatson@omen.com.au